

# Thrombosis and Haemostasis

## Multi-phased kinetics and interaction of protein kinase signaling in glycoprotein VI-induced platelet $\alpha$ IIb $\beta$ 3 integrin activation and degranulation

Pengyu Zhang, Saskia von Ungern-Sternberg, Luisa Hastenplug, Fiorella Solari, Albert Sickmann, Marijke Kuijpers, Johan W Heemskerk, Ulrich Walter, Kerstin Jurk.

Affiliations below.

DOI: 10.1055/a-2311-0117

Please cite this article as: Zhang P, von Ungern-Sternberg S, Hastenplug L et al. Multi-phased kinetics and interaction of protein kinase signaling in glycoprotein VI-induced platelet  $\alpha$ IIb $\beta$ 3 integrin activation and degranulation. *Thromb Haemost* 2024. doi: 10.1055/a-2311-0117

**Conflict of Interest:** JWMH is a scientific advisor for Synapse Research Institute.

**This study was supported by** European Union's Horizon 2020 research and innovation program under the Marie Skłodowska-Curie grant agreement TICARDIO , 813409

### Abstract:

**Background:** Platelet glycoprotein VI (GPVI) stimulation activates the tyrosine kinases Syk and Btk, and the effector proteins phospholipase C $\gamma$  2 (PLC $\gamma$ 2) and protein kinase C (PKC). Here, the activation sequence, crosstalk and downstream effects of this Syk-Btk-PKC signalosome in human platelets was analyzed.

**Methods and Results:** Using immunoblotting, we quantified 14 regulated phospho-sites in platelets stimulated by convulxin with and without inhibition of Syk, Btk or PKC. Convulxin induced fast, reversible tyrosine phosphorylation (pY) of Syk, Btk, LAT and PLC $\gamma$ 2, followed by reversible serine/threonine phosphorylation (pS/T) of Syk, Btk and downstream kinases MEK1/2, Erk1/2, p38 and Akt. Syk inhibition by PRT-060318 abolished all phosphorylations, except Syk pY352. Btk inhibition by acalabrutinib strongly decreased Btk pY223/pS180, Syk pS297, PLC $\gamma$ 2 pY759/Y1217, MEK1/2 pS217/221, Erk1/2 pT202/Y204, p38 pT180/Y182 and Akt pT308/S473. PKC inhibition by GF109203X abolished most pS/T phosphorylations except p38 pT180/Y182 and Akt pT308, but enhanced most Y-phosphorylations. Acalabrutinib, but not GF109203X, suppressed convulxin-induced intracellular Ca<sup>2+</sup> mobilization, whereas all three protein kinase inhibitors abolished degranulation and  $\alpha$ IIb $\beta$ 3 integrin activation assessed by flow cytometry. Inhibition of autocrine ADP effects by AR-C669931 partly diminished convulxin-triggered degranulation.

**Conclusion:** Kinetic analysis of GPVI-initiated multisite protein phosphorylation in human platelets demonstrates multiple phases and interactions of tyrosine and serine/threonine kinases with activation-altering feedforward and feedback loops partly involving PKC. The protein kinase inhibitor effects on multisite protein phosphorylation and functional readouts reveal that the signaling network of Syk, Btk and PKC controls platelet granule exocytosis and  $\alpha$ IIb $\beta$ 3 integrin activation.

### Corresponding Author:

Dr. Kerstin Jurk, University Medical Center of the Johannes Gutenberg University Mainz, Center for Thrombosis and Hemostasis (CTH), Mainz, Germany, kerstin.jurk@unimedizin-mainz.de

### Affiliations:

Pengyu Zhang, University Medical Center of the Johannes Gutenberg University Mainz, Center for Thrombosis and Hemostasis (CTH),

Mainz, Germany

Saskia von Ungern-Sternberg, University Medical Center of the Johannes Gutenberg University Mainz, Center for Thrombosis and Hemostasis (CTH), Mainz, Germany

Luisa Hastenplug, University Medical Center of the Johannes Gutenberg University Mainz, Center for Thrombosis and Hemostasis (CTH), Mainz, Germany

[...]

Kerstin Jurk, University Medical Center of the Johannes Gutenberg University Mainz, Preventive Cardiology and Preventive Medicine, Department of Cardiology, Mainz, Germany



This article is protected by copyright. All rights reserved.

Accepted Manuscript

This is a PDF file of an unedited manuscript that has been accepted for publication. As a service to our customers we are providing this early version of the manuscript. The manuscript will undergo copyediting, typesetting, and review of the resulting proof before it is published in its final form. Please note that during the production process errors may be discovered which could affect the content, and all legal disclaimers that apply to the journal pertain.

# Multi-phased kinetics and interaction of protein kinase signaling in glycoprotein VI-induced platelet $\alpha\text{IIb}\beta\text{3}$ integrin activation and degranulation

Pengyu Zhang<sup>1, 2, 3</sup>, Saskia von Ungern-Sternberg<sup>1</sup>, Luisa Hastenplug<sup>1</sup>, Fiorella A. Solari<sup>2</sup>, Albert Sickmann<sup>2, 5, 6</sup>, Marijke J. E. Kuijpers<sup>3</sup>, Johan W. M. Heemskerk<sup>3, 4</sup>, Ulrich Walter<sup>1\*</sup> and Kerstin Jurk<sup>1\*</sup>

1. Center for Thrombosis and Hemostasis (CTH), University Medical Center of the Johannes Gutenberg University Mainz, 55131 Mainz, Germany
2. Leibniz Institut für Analytische Wissenschaften-ISAS-e.V., 44139 Dortmund, Germany
3. Department of Biochemistry, Cardiovascular Research Institute Maastricht (CARIM), Maastricht University, Maastricht, The Netherlands
4. Synapse Research Institute Maastricht, Koningin Emmaplein 76217 KD Maastricht, The Netherlands
5. Medizinische Fakultät, Medizinisches Proteom-Center, Ruhr-Universität Bochum, 44780 Bochum, Germany
6. Department of Chemistry, College of Physical Sciences, University of Aberdeen, Aberdeen AB25 2ZD, UK

\*Correspondence: ulrich.walter@uni-mainz.de (U.W.); kerstin.jurk@unimedizin-mainz.de (K.J.)

Address for correspondence: Kerstin Jurk, PhD, Center for Thrombosis and Hemostasis (CTH), University Medical Center of the Johannes Gutenberg University Mainz, 55131, Mainz, Germany Email: kerstin.jurk@unimedizin-mainz.de

Ulrich Walter, MD

Center for Thrombosis and Hemostasis (CTH), University Medical Center of the  
Johannes Gutenberg University Mainz, 55131, Mainz, Germany

Email: ulrich.walter@uni-mainz.de

## Abstract

**Background** Platelet glycoprotein VI (GPVI) stimulation activates the tyrosine kinases Syk and Btk, and the effector proteins phospholipase Cy 2 (PLCy2) and protein kinase C (PKC). Here, the activation sequence, crosstalk and downstream effects of this Syk-Btk-PKC signalosome in human platelets was analyzed.

**Methods and Results** Using immunoblotting, we quantified 14 regulated phospho-sites in platelets stimulated by convulxin with and without inhibition of Syk, Btk or PKC. Convulxin induced fast, reversible tyrosine phosphorylation (pY) of Syk, Btk, LAT and PLCy2, followed by reversible serine/threonine phosphorylation (pS/T) of Syk, Btk and downstream kinases MEK1/2, Erk1/2, p38 and Akt. Syk inhibition by PRT-060318 abolished all phosphorylations, except Syk pY352. Btk inhibition by acalabrutinib strongly decreased Btk pY223/pS180, Syk pS297, PLCy2 pY759/Y1217, MEK1/2 pS217/221, Erk1/2 pT202/Y204, p38 pT180/Y182 and Akt pT308/S473. PKC inhibition by GF109203X abolished most pS/T phosphorylations except p38 pT180/Y182 and Akt pT308, but enhanced most Y-phosphorylations. Acalabrutinib, but not GF109203X, suppressed convulxin-induced intracellular Ca<sup>2+</sup> mobilization, whereas all three protein kinase inhibitors abolished degranulation and  $\alpha$ IIb $\beta$ 3 integrin activation assessed by flow cytometry. Inhibition of autocrine ADP effects by AR-C669931 partly diminished convulxin-triggered degranulation.

**Conclusion** Kinetic analysis of GPVI-initiated multisite protein phosphorylation in human platelets demonstrates multiple phases and interactions of tyrosine and serine/threonine kinases with activation-altering feedforward and feedback loops partly involving PKC. The protein kinase inhibitor effects on multisite protein phosphorylation and functional readouts reveal that the signaling network of Syk, Btk and PKC controls platelet granule exocytosis and  $\alpha$ IIb $\beta$ 3 integrin activation.

## Keywords

collagen receptor, kinase inhibitors, Bruton's tyrosine kinase, protein kinase C, secretion

## Introduction

Platelets have crucial roles in hemostasis, thrombo-inflammation, infection, and cancer.<sup>1, 2</sup> Membrane-proteins such as G-protein coupled receptors (GPCRs) and tyrosine (Y)-protein kinase-linked receptors mediate the activation of platelets in response to numerous agonists.<sup>3, 4</sup> GPCRs include receptors for thrombin (PAR1, PAR4), thromboxane A<sub>2</sub> (TP) and ADP (P2Y<sub>1</sub>, P2Y<sub>12</sub>)<sup>2, 5</sup>, tyrosine kinase-linked receptors are glycoprotein VI (GPVI), C-type lectin receptor-2 (CLEC-2), GPIb $\alpha$ , Fc $\gamma$ RIIA and integrin  $\alpha$ IIb $\beta$ 3<sup>2, 6</sup>. Since there is a growing need to control platelet hyperreactivity, new approaches to inhibit platelets are sought.<sup>2</sup>

GPVI, a platelet-specific tyrosine kinase-linked collagen receptor, signals via the Fc receptor  $\gamma$ -chain and the spleen tyrosine kinase (Syk), similar to the signaling of the B cell receptor (BCR) and related immune receptors.<sup>7, 8</sup> B cell studies originally established that a BCR-/ITAM-induced and membrane-associated Src/Syk/PI3K/Btk/PLC $\gamma$ 2 signalosome with additional signaling components (PKCs,

Akt, calcineurin, mitogen-activated protein kinases (MAPKs) nuclear factors) controls final B cell responses.<sup>9,10</sup>

The BCR signalosome concept was readily transferred to platelets and the ITAM-based signaling complexes induced by GPVI or CLEC-2 activation.<sup>8, 9</sup> GPVI agonists including collagen, cross-linked collagen-related peptide (CRP-XL) and the snake venom toxin convulxin, activate platelets via Src family kinases (SFKs) which induce dual Y-phosphorylation of proteins with the immunoreceptor tyrosine-based activation motif (ITAM).<sup>9</sup> This recruits the SH2 domain-containing Syk, to the membrane followed by SFK-mediated Syk Y352 phosphorylation and kinase activation associated with autophosphorylation (Y525/526).<sup>9, 11</sup> Syk substrates are linker for activation of T cells (LAT) and Bruton's tyrosine kinase (Btk), which stimulate Y-phosphorylation/ activation of phospholipase Cy 2 (PLCy2) and platelet activation.<sup>12</sup>

GPVI-stimulation also activates phosphoinositide 3-kinases (PI3Ks) by their recruitment to membranes via their SH2-domain binding to Y-phosphorylated proteins such as LAT or by interaction with GPCR  $\beta\gamma$  subunits.<sup>13</sup> Activated PI3Ks via their product phosphatidylinositol 3,4,5-trisphosphate (PIP<sub>3</sub>) also recruit PH-domain containing proteins (i.e., PLCy2, Btk, Akt) to the membranes and activates them.<sup>13</sup>

However, the sequential signaling events in ITAM-mediated responses, the interactions of Y- with S/T-protein kinases, the crosstalk with other pathways and the coupling to specific functional responses are not well defined. Recent developments of selective and potent kinase inhibitors of the ITAM signaling components Syk, PI3K and Btk provide novel approaches to study this pathway in human platelets.<sup>2</sup>

Syk inhibitors and first/second generation Btk inhibitors, ibrutinib and acalabrutinib, respectively, inhibited various functions of human platelets and

tyrosine phosphorylation of downstream targets.<sup>14-18</sup> Earlier studies showed that ibrutinib strongly inhibits many tyrosine kinases including SFKs and Tec in addition to Btk, whereas acalabrutinib is Btk selective.<sup>19</sup> Antiplatelet effects of several novel Btk/Syk inhibitors<sup>17</sup> and reversible/irreversible Btk inhibitors were compared<sup>20, 21</sup>, but with limited phosphorylation data. In contrast, extensive phosphoproteomic data were obtained with GPVI-activated human platelets<sup>22</sup> and compared with functional effects of several Syk and Btk inhibitors.<sup>23</sup> These studies provided substantial evidence for the important role of tyrosine kinases and especially Btk in GPVI-induced platelet activation, but the phosphorylation data had limitations. Most studies used only 1 time point after activation, indicating that the data reported represent a static snapshot, and not a dynamic view on platelet signaling. Most papers also primarily addressed Y-phosphorylation of Syk, Btk and their direct substrates LAT, PLC $\gamma$ 2, but not additional S/T protein kinases. PKC activation was analyzed by phosphoantibodies against PKC consensus phosphosites<sup>14, 22</sup>, similarly also Akt and MAPK<sup>22</sup>. However, these procedures do not detect specific substrates.

Many tyrosine protein kinases are known to be regulated by S/T protein kinases, but this has been rarely studied in human platelets. In our previous phosphoproteomic approaches, we detected numerous ADP- and/or prostacyclin (PGI<sub>2</sub>)-regulated phosphoproteins in human platelets and noted that ADP stimulated S/T phosphorylation of several tyrosine protein kinases such as JAK3, Btk, TNK2, Syk.<sup>24</sup> Previously, we focused on the regulation of the individual platelet tyrosine protein kinases Syk and Btk. Analysis of Syk serine phosphorylation in response to GPIIb $\alpha$  stimulation by beads coated with the toxin echicetin, GPVI stimulation by the toxin convulxin and by ADP detected prominent Syk S297 phosphorylation preferentially dependent on PKC $\alpha/\beta$ .<sup>25, 26</sup> Syk S297 phosphorylation was negatively



affected by PKA or the protein phosphatase 2A (PP2A) and correlated well with reduced Syk Y-phosphorylation/kinase activity.<sup>26, 27</sup> We also compared the differential regulation of Syk and Btk by PKC, PKA and PP2A in human platelets and noted that PP2A does not directly affect Btk pS180.<sup>28</sup>

Now, we hypothesized that the analysis of GPVI-activated multisite protein phosphorylation kinetics in human platelets identifies interactions of key Y-kinases (SFK, Syk, Btk) and S/T-kinases (PKC, MEK1/2, Erk1/2, p38, Akt) within a signaling network, which is required for granule exocytosis and  $\alpha$ IIb $\beta$ 3 integrin activation. To define time-dependent dynamics of GPVI signaling in human platelets, we quantified relevant convulxin-regulated phosphoproteins (14 phospho-sites) during an extended activation time of 10-300 s and 6 different time points. Interactions of GPVI-stimulated Y- and S/T-protein kinases and resulting functional effects on platelets, in particular regulation of intracellular Ca<sup>2+</sup> mobilization, degranulation and  $\alpha$ IIb $\beta$ 3 integrin activation, were assessed by the effects of selective inhibition of Syk, Btk and PKC.

## Methods

### Reagents and antibodies

Convulxin and GF109203X were obtained from Enzo Life Sciences (Lausen, Switzerland). PRT-060318 was from Selleckem (Houston, TX, USA). Acalabrutinib was purchased from Abcam (Cambridge, UK). AR-C669931 (AR-C) was from the Medicines Company (Parsippany, NJ, USA). Total Syk (4D10), total PLC $\gamma$ 2 (B-10) and total Akt1 (B-1) antibodies were from Santa Cruz Biotechnology (Dallas, TX, USA). Phospho-Syk (S297, Y352, Y525/526), total Btk (D3H5), phospho-Btk (S180, Y223, Y551), phospho-PLC $\gamma$ 2 (Y759, Y1217), phospho-LAT Y220, phospho-Akt



(T308, S473), phospho-MEK1/2 S217/S221, phospho-Erk1/2 T202/Y204, phospho-p38 T180/Y182, total MEK1/2,  $\alpha$ -actinin and  $\beta$ -actin were provided by Cell Signaling Technologies (Danvers, MA, USA). Secondary horseradish peroxidase (HRP)-conjugated goat anti-rabbit/mouse antibodies were obtained from BioRad Laboratories (Hercules, CA, USA). FITC-conjugated mouse anti-human CD62P, CD63 and PAC-1 antibodies were from BD Biosciences (Heidelberg, Germany).

### **Blood donors, ethics approval and informed consent**

Blood collection was performed as previously described.<sup>28</sup> This study was approved in accordance with the Declaration of Helsinki by the local Ethics Committee of the University Medical Center Mainz (study no. 837.302.12; 25.07.12; 2018-13290\_1; 27.07.2018).

### **Isolation of human platelets and preparation of Fura-2-loaded platelets**

For immunoblotting and flow cytometry, human platelets were washed and isolated as previously described.<sup>28</sup> For the measurement of cytosolic  $\text{Ca}^{2+}$  rises, the protocol was slightly modified based on our previous publication.<sup>29</sup> Briefly, platelet-rich plasma (PRP) was prepared via centrifugation at 260 x g for 10 min at room temperature (RT), supplemented with 1:10 vol/vol acid citrate dextrose (ACD) (80 mM trisodium citrate, 183 mM glucose, 52 mM citric acid). Platelets in PRP were pelleted by centrifugation at 2360 x g for 2 min and resuspended in HEPES buffer (136 mM NaCl, 2.7 mM KCl, 2 mM  $\text{MgCl}_2$ , 5.5 mM glucose, 10 mM HEPES, 0.1% BSA, pH 6.6) in the presence of apyrase (1 U/mL) and 1:15 vol/vol ACD. After a further centrifugation step, platelets were resuspended in HEPES buffer (150 mM NaCl, 5 mM KCl, 1 mM  $\text{MgCl}_2$ , 5 mM glucose, 10 mM HEPES, pH 7.5) and loaded

with Fura-2 acetoxymethyl ester (3  $\mu$ M) and Pluronic (0.4  $\mu$ g/mL) for 30 min at RT. Fura-2-loaded platelets were adjusted to a platelet concentration of  $2 \times 10^8$ /mL with HEPES buffer, pH 7.5.

### **Light transmission aggregometry (LTA)**

LTA was performed as previously described.<sup>28</sup> Briefly, using an Apact4S Plus aggregometer (DiaSys, Flach, Germany), washed human platelets (200  $\mu$ L,  $3 \times 10^8$ /mL) were pre-incubated with vehicle control (0.1% DMSO), 1  $\mu$ M PRT-060318, 5  $\mu$ M acalabrutinib or 5  $\mu$ M GF109203X for 5 min at 37°C and then stimulated by 50 ng/mL convulxin under stirring. Samples for immunoblotting were collected at 0 s, 10 s, 30 s, 60 s, 120 s and 300 s, by adding 100  $\mu$ L of 3 $\times$  Lämmli buffer (200 mM Tris/HCl, 15% (v/v) glycerol, 6% (w/v) SDS, 0.06% (w/v) bromophenol blue, 1:10  $\beta$ -mercaptoethanol), and boiled for 10 min at 95 °C with gentle shaking.

### **SDS-PAGE and immunoblotting analysis of phosphoproteins**

SDS-polyacrylamide electrophoresis (SDS-PAGE), immunoblotting and phosphoprotein analysis were performed as previously described.<sup>28</sup> Briefly, proteins in prepared samples were separated by 8% gels and transferred to polyvinylidene fluoride membranes (PDVF). After blocking membranes with 2% BSA in 1 $\times$ TBS-T for 1 h at RT, the membranes were incubated overnight at 4 °C with specific antibodies with 2% BSA in 1 $\times$  TBS-T. The incubated membranes were washed 3 times with 1 $\times$  TBS-T and incubated with relevant horseradish peroxidase (HRP)-conjugated secondary antibody for 2 h at RT with 2% BSA in 1 $\times$  TBS-T, and then rewash 3 times with 1 $\times$  TBS-T. The membranes were developed by electrochemiluminescence (ECL) detection. The antibodies used are listed above. An alternative fluorescence-

based detection system [IRDye® 800 CW goat anti-rabbit (LiCor®); Bio-Rad ChemiDoc MP Imaging System] was also used with selected platelet samples and compared with our regular ECL detection system, and found superiority of the latter in terms of signal sizes and signal to noise ratios.

### **Measurement of calibrated changes in cytosolic Ca<sup>2+</sup> rises**

Using a high-throughput FlexStation 3 device (Molecular Devices, San Jose, USA), the elevation of intracellular Ca<sup>2+</sup> in Fura-2-loaded platelets was measured in 96-well plates as previously described.<sup>30</sup> Briefly, 200 µL of platelets/well (2 x 10<sup>8</sup>/mL) were pretreated with PRT-060318, acalabrutinib or GF109203X for 10 min at 37 °C. The platelet suspension was supplemented with vehicle (HEPES buffer, pH 7.5) or 0.1 mM EGTA as needed before starting the measurement. Convulxin (final concentration 50 ng/mL) was injected by automatic pipetting at a high rate of 125 µL/s for maximal platelet response. For each column, fluorescence responses were monitored for 10 min at 37 °C, recording 510 nm emission fluorescence at two excitation wavelengths (340 and 380 nm). The Fura-2 fluorescence ratio of each well was acquired every 4 s. The calibration wells contained Fura-2-loaded platelets and 0.1% Triton-X-100 in the presence of either 2 mM CaCl<sub>2</sub> or 1 mM EGTA/Tris for determining R<sub>max</sub> and R<sub>min</sub> values, thus resulting in nanomolar changes in intracellular Ca<sup>2+</sup>. Duplicate time traces capturing nanomolar changes in intracellular Ca<sup>2+</sup> concentration were subjected to floating-point averaging via an Excel script. These traces were subsequently assessed for the area under the curve (AUC, expressed in nM x s) over a 10-min period.<sup>31</sup> To facilitate comparisons across different experimental days involving various blood donors, curve parameters were normalized against the control condition, specifically when the agonist was

administered with a vehicle medium and no inhibitor. This control condition was standardized at 100%. The subsequent analysis of inhibitor effects involved expressing these effects as percentage changes relative to the established control condition. Notably, the normalization process was independently conducted for experimental runs featuring either CaCl<sub>2</sub> or EGTA.

### **Flow cytometry**

After incubation with PRT-060318, acalabrutinib or GF109203X for 5 min or with AR-C669931 for 15 min at 37 °C, washed human platelets ( $2 \times 10^8$ /mL) were stimulated with 50 ng/ml convulxin for 5 min at RT. Platelets were stained with PAC-1-FITC (recognizing activated  $\alpha$ IIb $\beta$ 3 integrin), anti-CD63-FITC, or anti-CD62P-FITC antibodies for 10 min at RT and then fixed with formaldehyde in HEPES buffer (final concentration 0.5%) for 30 min at RT, followed by adding 1 mL HEPES buffer (pH 7.4) to stop fixation. After centrifugation at 800 x g for 10 min, platelets were resuspended in 500  $\mu$ l of HEPES buffer (pH 7.4) and analyzed by flow cytometry using a BD FACSCANTO II and FACS DIVA software (BD biosciences, Heidelberg, Germany) as previously described.<sup>32</sup>

### **Statistical analysis**

Data are presented as means  $\pm$  standard deviation (SD), from  $n \geq 3$  independent experiments with platelets from at least three healthy donors. Statistical analysis was performed using GraphPad Prism 9.5.1 (GraphPad Software, San Diego, CA, USA). One-way or two-way ANOVA, followed by a Sidak's multiple comparison test, was used for the comparison of more than two groups. A p-value  $< 0.05$  was considered significant.

## Results

### **Convulxin induces very rapid, reversible Y-phosphorylation, followed by delayed, also reversible multisite S/T-phosphorylation of Syk, Btk and downstream targets**

For the kinetic experiments, we preferred to use the tetrameric C-type lectin convulxin, since it dimerizes and further clusters very rapidly the GPVI receptor molecules in contrast to the cross-linked CRP polypeptide. Using convulxin, we were able to distinguish between very early, intermediate and later protein phosphosites and also to detect reversible protein phosphorylation within 5 minutes.

Convulxin induces phosphorylation of Syk (Y352, Y525/526, S297) and Btk (Y551, Y223, S180) in human platelets.<sup>28</sup> These earlier studies used a limited activation window time, a small phosphosite spectrum and primarily addressed Syk and Btk. Here, we significantly extended the time courses to compare early phosphorylation changes (at 10 s and 30 s) and later events up to 300 s. Furthermore, we enlarged the spectrum of analyzed phospho-sites to other protein kinases with suspected involvement in long-term GPVI signaling. These include the MAPK-related kinases, MEK1/2, Erk1/2 and p38, and the PI3K-dependent kinase Akt.<sup>13, 33, 34</sup> We analyzed phospho-sites known to be clearly linked to activation of the defined protein kinases and /or to serve as a direct substrate of these kinases (Supplementary Table 1).

In human platelets stimulated with the GPVI agonist convulxin we determined, with several time points within 300 s activation, the phosphorylation effects using a panel of 14 specific phospho-antibodies, recognizing the following phosphoproteins: Syk (S297, Y352, Y525/526), LAT (Y220), Btk (S180, Y223, Y551), PLC $\gamma$ 2 (Y759, Y1217), MAPKs (MEK1/2 S217/221, Erk1/2 T202/Y204, p38 T180/Y182) and Akt

(T308, S473). We found an equally rapid and strong convulxin-induced Y-phosphorylation of Syk and Btk, which was maximal within 10 sec, reversible and preceded their S-phosphorylation (Fig. 1A, B). Next to PLC $\gamma$ 2 and LAT, also the MAPKs MEK1/2, Erk1/2 and p38 showed a reversible pattern of phosphorylation (Fig. 1A, B). In contrast, the Akt T308 and S473 phosphorylation was slower in onset and more persistent (Supplementary Fig. 1). Overall, this kinetic analysis indicated that the Y-phosphorylation of Syk, LAT, Btk and PLC $\gamma$ 2 preceded the S/T phosphorylation of Syk, Btk, MEK1/2, Erk1/2, p38 and Akt. At longer time points, all phosphorylation events, except for Akt, reversed within the 5-min stimulation period, indicating the activity of Y/S/T protein phosphatases.

### **Inhibition of Syk, Btk or PKC differentially affects the convulxin-induced multisite protein phosphorylation**

To further investigate the hierarchy of protein kinases in the GPVI signaling pathway, we then systematically studied the effects of Syk, Btk or PKC inhibitors on protein phosphorylation events in the GPVI signalosome.

In human platelets, the compound PRT-060318 (1  $\mu$ M) has been characterized as a selective Syk inhibitor.<sup>25, 35, 36</sup> We first confirmed that PRT-060318 blocked the convulxin-induced Syk Y525/526 phosphorylation, as an indicator of Syk activity (Fig 2). However, it did not inhibit, even increased Syk Y352 phosphorylation, an established SFKs substrate sequence. Syk inhibition also strongly suppressed Syk S297 phosphorylation and other Y/S/T phospho-sites, i.e., LAT, Btk, PLC $\gamma$ 2, MEK1/2, Erk1/2, p38 and Akt (Fig. 2, Supplementary Fig. 1). Overall, this indicated that these phosphorylation events are downstream of the activated Syk kinase.



Second, we compared the roles of Syk and Btk in the GPVI-signalosome by using the Btk inhibitor, acalabrutinib. Platelet treatment with acalabrutinib abolished the phosphorylation of Btk Y223 (Fig. 3), a well-known Btk autophosphorylation site representing Btk activity (Supplementary Table 1), under basal and convulxin-stimulated conditions. Acalabrutinib also strongly inhibited the convulxin-stimulated phosphorylation of PLC $\gamma$ 2 Y759/Y1217, MEK1/2 S217/221, Erk1/2 T202/Y204, p38 T180/Y182, Syk S297, Btk S180 (Fig 3) and Akt T308/S473 (Supplementary Fig. 2), but not of Syk Y352, Y525/526, LAT Y220 and Btk Y551 (Fig. 3). Interestingly, acalabrutinib, similar to PRT, moderately increased Syk Y352 phosphorylation, which was statistically not significant. These data hence indicate that Btk, but not Syk, controls PLC $\gamma$ 2 Y-phosphorylation/activation, Syk S297/Btk S180 phosphorylation and MEK1/2, Erk1/2, p38, Akt activation. However, also Syk may regulate these functions indirectly via Btk.

Third, we examined the role of PKC activity in the GPVI-signalosome. Previously, we characterized GF109203X (5  $\mu$ M) as a potent and selective human platelet pan-PKC inhibitor and reported that PKC isoforms (most likely PKC  $\alpha/\beta$ ) regulate Syk S297 and Btk S180 phosphorylation as a negative feedback mechanism.<sup>27, 28</sup> With the extended time courses and the broader spectrum of analyzed phosphoproteins, we now monitored effects of GF109203X on convulxin-induced protein phosphorylation of Syk, LAT, Btk, PLC $\gamma$ 2, Akt and MAPKs. GF109203X clearly enhanced the convulxin-induced Y-phosphorylation of Syk Y525/526, LAT Y220 and PLC $\gamma$ 2 Y759/1217, moderately increased Syk pY352, while it strongly reduced S-phosphorylation of Syk S297 and Btk S180 (Fig. 4). Importantly, GF109203X also abolished the phosphorylation of MEK1/2 S217/221 and Erk1/2 T202/Y204, but not of p38 T180/Y182 (Fig. 4). GF109203X inhibited



convulxin-induced Akt S473 phosphorylation, especially at 5 min, but not of Akt T308 (Supplementary Fig. 3).

At the functional level of platelet activation, we confirmed our results<sup>25, 26, 28</sup> that both 1  $\mu$ M PRT-060318 and 5  $\mu$ M acalabrutinib abolished the convulxin-induced platelets aggregation, while 5  $\mu$ M GF109203X had an only slightly inhibitory effect (data not shown). We then extended these studies to the analysis of convulxin-stimulated intracellular  $\text{Ca}^{2+}$  levels, granule secretion and  $\alpha\text{IIb}\beta\text{3}$  integrin activation.

### **Inhibition of Btk but not PKC suppresses convulxin-induced intracellular $\text{Ca}^{2+}$ rises**

The GPVI-dependent activation of PLC $\gamma$ 2 requires multisite Y-phosphorylation and recruitment to the membrane via its SH2- and/or PH domain.<sup>13</sup> Activated PLC $\gamma$ 2 catalyzes the conversion of phosphatidylinositol 4,5-trisphosphate ( $\text{PIP}_2$ ) to  $\text{IP}_3$  resulting in the mobilization of  $\text{Ca}^{2+}$  from the dense tubular system to the cytoplasm with concomitant platelet activation.<sup>12</sup> The data so far indicated that the convulxin-induced PLC $\gamma$ 2 Y-phosphorylation (Y759, Y1217) was inhibited by PRT-060318 and acalabrutinib but was increased by GF109203X. Strong inhibition of GPVI-activated PKC (likely  $\alpha/\beta$  isoforms) by GF109203X was demonstrated by the downregulation of Syk S297 and Btk S180 phosphorylation.

To further clarify this phenomenon, regulation of cytosolic  $\text{Ca}^{2+}$  in Fura-2-loaded platelets was monitored using a high-throughput FlexStation 3 robot system. Experiments were performed in the absence and presence of EGTA to elucidate the effects on intracellular  $\text{Ca}^{2+}$  mobilization. Acalabrutinib (0.3-10  $\mu$ M) dose-dependently inhibited the  $\text{Ca}^{2+}$  rise upon convulxin stimulation in either condition, as visualized by area-under-the-curve analysis (Fig. 5A). Even 1  $\mu$ M acalabrutinib had strong

inhibitory effects. In contrast, GF109203X caused a different pattern of agonist response. At low doses GF109203X (0.3-1  $\mu\text{M}$ ) slightly increased, whereas at high doses it did not reduce the  $\text{Ca}^{2+}$  mobilization induced by convulxin (Fig. 5B).

### **Inhibition of Syk, Btk and PKC affects convulxin-induced degranulation and $\alpha\text{IIb}\beta\text{3}$ integrin activation**

Platelet granule secretion is tightly regulated by multiple platelet agonists.<sup>37</sup> Since both elevated  $\text{Ca}^{2+}$  level and PKC activity are essential for platelet degranulation<sup>37, 38</sup>, we determined effects of the same Syk, Btk and PKC inhibitors on the convulxin-induced degranulation and, in comparison,  $\alpha\text{IIb}\beta\text{3}$  integrin activation. At 1  $\mu\text{M}$  PRT-060318, 1-5  $\mu\text{M}$  acalabrutinib and 5  $\mu\text{M}$  GF109203X strongly inhibited, while at 1  $\mu\text{M}$  GF109203X only partially reduced the expression of CD63 (Fig. 6A) and CD62P (Fig. 6B), surface expression markers for  $\delta$ - and  $\alpha$ -granule exocytosis, respectively. Similar inhibitory effects were observed for the convulxin-stimulated PAC-1 antibody binding, as a marker for  $\alpha\text{IIb}\beta\text{3}$  integrin activation (Fig. 6C). These data indicate that both GPVI-induced platelet granule secretion and  $\alpha\text{IIb}\beta\text{3}$  integrin activation require all three protein kinases investigated, Syk, Btk and PKC.

### **P2Y<sub>12</sub> receptor blockade partially impairs convulxin-stimulated granule secretion**

The release of ADP from the  $\delta$ -granules and subsequent activation of the platelet ADP receptors P2Y<sub>1</sub> and especially P2Y<sub>12</sub> are positive feedback mechanism to enhance the functional effects of GPVI agonists.<sup>33, 39</sup> We confirmed that the P2Y<sub>12</sub> receptor antagonist AR-C669931 dose-dependently (2.5-1000 nM) reduced the convulxin-stimulated CD63 and CD62P surface expression, and the PAC-1 antibody

binding (Fig. 7). Interestingly, treatment of platelets with 500 nM AR-C669931 resulted in partial reduction of  $\delta$ -granule (CD63) (Fig. 7A) and  $\alpha$ -granule (CD62P) (Fig. 7B) release of about 50%, whereas  $\alpha$ IIb $\beta$ 3 integrin activation was nearly abolished (Fig. 7C). The data indicate a differential regulation, at least quantitatively, of  $\alpha/\delta$ -granule secretion and integrin activation by secreted ADP in response to GPVI stimulation.

## Discussion

In this study, GPVI-stimulated multisite protein phosphorylation in human platelets demonstrates a multiple phased kinetic pattern and interactions between tyrosine- and serine/threonine protein kinases with reversible activation and feedback regulation, thereby controlling degranulation and  $\alpha$ IIb $\beta$ 3 integrin activation.

### **GPVI-stimulation by convulxin induces reversible phosphorylation of S/T-kinases after initial Y-phosphorylation of the GPVI-LAT signalosome in a partly PKC-dependent manner**

The revealed transient, reversible nature of convulxin-induced Y/S/T-phosphorylation indicates a powerful role of both Y- and S/T-protein phosphatases in human platelets.<sup>40-42</sup> For instance, the prominent tyrosine phosphatase TULA-2 dephosphorylates Y-phosphorylated Syk and antagonizes GPVI-signaling<sup>43</sup>, whereas the ST protein phosphatase PP2A dephosphorylates Syk pS297 and components of MAPK signaling<sup>27, 42</sup>. Interestingly, platelet tyrosine phosphorylation induced by GPVI and CLEC-2 activation was sustained for 50 min, when aggregation was prevented by eptifibatide<sup>18</sup>, suggesting that dephosphorylation can also be controlled.

Most phospho-sites studied here are located within the kinase domains and are indicators for their activation, namely Syk Y525/526, Btk Y551, MEK1/2 S217/221, Erk1/2 T202/Y204, p38 T180/Y182, and Akt T308/S473. Other sites are located within regulatory domains, which are essential for kinase activation (Syk Y352) or have regulatory effects (Syk S297, Btk S180, Btk Y223). The Syk and Btk phospho-sites are well studied at the kinase level<sup>9-11</sup>, and documented in the PhosphoSitePlus database.

Understanding the hierarchy, interactions and functional impact of the protein kinases requires information on the human platelet proteome and kinome<sup>41, 44</sup>, properties of the protein kinase inhibitors and on their effects on platelets<sup>2</sup>. Because of the important role of Syk (abundant in human platelets, ~0.78  $\mu$ M) in inflammation and immune cell diseases, several potent Syk inhibitors have been developed for clinical use. The Syk inhibitor PRT-060318 strongly inhibited purified Syk (IC<sub>50</sub> 4 nM), and the activation and function of Syk in murine and human platelets.<sup>25, 35, 36</sup> It was reported that Syk, Btk and PKC inhibitors did not block convulxin-induced phosphorylation of Syk Y352, a SFK-specific phospho-site essential for Syk activation<sup>11</sup>, indicating that SFKs are still operative under these conditions. We also find that PRT-060318 (1  $\mu$ M) even prolongs the GPVI-induced Syk Y352 phosphorylation, suggesting that Syk inhibition enhances SFK activation, and Syk activation down-regulates the SFK-increased Syk pY352. It was reported that acalabrutinib-induced Btk inhibition caused Src potentiation in human platelets<sup>14</sup>, but this was less apparent in our experiments. On the other hand, PRT-060318 abolished Syk Y525/526 and other phospho-sites studied, indicating that Syk acts upstream of LAT, Btk, PLC $\gamma$ 2, PKC and MAPKs. In immune cells, LAT is phosphorylated primarily by Syk at four conserved Y-sites (Y161, Y200, Y220, Y255),

which serve as docking sites for SH2-domain-containing proteins (e.g., PLC $\gamma$ 2/1, PI3K, Btk).<sup>45</sup>

Another important tyrosine kinase within platelet GPVI signaling is Btk, a member of the Tec family.<sup>12</sup> Btk deficiency or dysfunction causes X-linked agammaglobulinaemia (XLA), characterized by a severe impairment of B cell development and function.<sup>10</sup> XLA platelets show an only moderate impairment of GPVI signaling, likely due to a redundant role of Tec.<sup>12, 15</sup> Since Btk is crucially involved in B cell differentiation and malignancies, several inhibitors of human Btk have been developed and clinically validated. Ibrutinib, a first generation Btk inhibitor, strongly and irreversibly inhibited Btk (targeting Cys 481), but it also showed off-target effects on other tyrosine kinases including SFKs. The second generation inhibitor acalabrutinib is more specific for Btk and Tec (Btk IC<sub>50</sub> 5 nM, Tec IC<sub>50</sub> 83 nM, no effect on SFKs) and also irreversibly binds to Btk Cys 481.<sup>19</sup> In this landmark clinical study, acalabrutinib plasma levels of 1.2–1.4  $\mu$ M were detected in individuals taking 100 mg of acalabrutinib twice daily. This was accompanied by high Btk target occupancy in peripheral blood monocytes (>90%) with concomitant reduction of Btk Y223 autophosphorylation.<sup>19</sup> Based on this and the considerable expression levels in human platelets (Btk  $\sim$ 1.76  $\mu$ M, Tec  $\sim$ 0.21  $\mu$ M), we analyzed the effects of acalabrutinib on platelet protein phosphorylation. Acalabrutinib (5  $\mu$ M) strongly and specifically inhibited phosphorylation of Btk Y223, PLC $\gamma$ 2 and MAPKs. An earlier report on B cells showed for PLC $\gamma$ 2 that phosphorylation of 4 conserved Y-sites (Y753, Y759, Y1197, Y1217) is essential for full PLC $\gamma$ 2 activation, mediated primarily by Btk.<sup>46</sup> In the present case, acalabrutinib abolished the GPVI-induced phosphorylation of PLC $\gamma$ 2 Y759 and Y1217, but not of Syk Y352 (SFKs site), Syk Y525/526 (Syk autophosphorylation), LAT Y220 and Btk Y551 (Syk site). Thus, the

GPVI-induced PLC $\gamma$ 2 Y759/Y1217 phosphorylation is directly mediated by Btk, and indirectly controlled by Syk and SFKs, which is consistent with another report.<sup>15</sup>

Our results on a GPVI-induced sequential phosphorylation in platelets are summarized in Table S1 and compared with database information. Useful protein kinase activity markers appear to be for: (1) SFK activity: Syk pY352; (2) Syk activity: Syk pY525/526, LAT pY220, Btk pY551 and, (3) Btk activity: Btk pY223, PLC $\gamma$ 2 pY759/Y1217. It appears that the other S/T phospho-sites studied, inhibited by acalabrutinib or GF109203X, are downstream of both Btk and PKC. Furthermore, p38 pT180/Y182 and Akt pT308 events are downstream of Btk, but not of PKC.

### **Markers for tyrosine and serine/threonine protein kinase activities in the platelet Btk-PLC $\gamma$ 2-PKC signalosome**

In B cells, Btk activates PLC $\gamma$ 2 followed by the activation of PKC $\beta$ , MAPKs, calmodulin/calcineurin, Akt and several transcription factors, which are all important for B cell development and functions.<sup>10</sup> Much less is known about related pathways in platelets. In platelets, PLC $\gamma$ 2 activation induces IP $_3$ -mediated intracellular Ca<sup>2+</sup> mobilization from the dense tubular system with subsequent Ca<sup>2+</sup>-dependent responses and also increases diacylglycerol formation with activation of PKC isoforms.<sup>3, 4</sup> In agreement with this, acalabrutinib (5  $\mu$ M) abolished the GPVI-induced intracellular Ca<sup>2+</sup> elevation and the Syk S297 and Btk S180 phosphorylation. Previously, we reported that the GPVI-induced Syk S297 and Btk S180 phosphorylation is mediated by one of the conventional PKC isoforms, and that this represents a possible inhibitory feedback mechanism of GPVI signaling.<sup>26, 28</sup> Our present data show that the PKC inhibitor GF109203X (likely via PKC $\alpha/\beta$ ) abolishes GPVI-induced phosphorylation of Syk pS297 and Btk pS180, but enhances the Y-



phosphorylation of Syk, LAT and PLC $\gamma$ 2, as well the intracellular Ca<sup>2+</sup> rise. These data are consistent with B cell studies showing that the PKC $\beta$ -mediated phosphorylation of Syk S297 and Btk S180 attenuates the membrane localization and activation of these protein kinases.<sup>47, 48</sup>

Interestingly, Akt decreased the activity of several B-cell receptor signaling targets, including Btk, Blink and Syk.<sup>49</sup> In platelets, the convulxin-induced and PKC-mediated phosphorylation of Syk S297 and Btk S180 is rapid (maximal within 30 s) and closely follows Btk / PLC $\gamma$ 2 activation, and is therefore a useful marker for GPVI-induced PKC activity. Inhibition of PKC with GF109203X strongly inhibited the phosphorylation of more distal PKC targets such as MEK1/2 S217/221, Erk1/2 T202/Y204, and Akt S473, but not p38 T180/Y182 or Akt pT308.

### **PKC-dependent protein phosphorylation phases induced by GPVI-mediated Btk activation are required for granule exocytosis and $\alpha$ IIb $\beta$ 3 integrin activation**

Based on the observed effects of the protein kinase inhibitors PRT-060318 (Syk), acalabrutinib (Btk) and GF109203X (likely PKC $\alpha/\beta$  isoforms) on GPVI-stimulated multisite phosphorylation, we got evidence that the interactions of Syk, Btk and PKC control platelet granule secretion and  $\alpha$ IIb $\beta$ 3 integrin activation. However, the PKC inhibitor GF109203X at 1  $\mu$ M showed less strong inhibitory functional effects. Possibly, inhibitor concentrations saturating for PKC were not reached, as the intraplatelet concentration of the conventional PKC $\alpha$  and PKC $\beta$  isoforms can be calculated as  $\sim$ 2.9  $\mu$ M. Increasing the concentration of GF109203X to 5  $\mu$ M resulted in a similarly strong inhibition of these responses as with PRT-060318 or acalabrutinib. While PKC and Ca<sup>2+</sup>-regulated pathways are known to regulate



platelet granule release<sup>37</sup>, other protein kinases such as MAPKs and Akt may also contribute. In a previous phosphoproteomic study, we observed that multiple proteins of the platelet secretory machinery are regulated at the phosphorylation level by ADP.<sup>24</sup> This is relevant in the present context since ADP is released from the  $\delta$ -granules and subsequently stimulates the P2Y<sub>1</sub> and P2Y<sub>12</sub> receptors.<sup>39</sup> We found that the P2Y<sub>12</sub> blocker AR-C669931, at 1  $\mu$ M reduced the convulxin-induced  $\delta$ -granule and  $\alpha$ -granule exocytosis up to 50%, whereas this abolished the  $\alpha$ IIb $\beta$ 3 integrin activation, suggesting that the convulxin-stimulated platelet degranulation is only partly controlled by the P2Y<sub>12</sub> pathway. Interactions of P2Y<sub>12</sub> and GPVI signaling are clinically relevant, as ADP enhances GPVI signaling.<sup>50</sup>

Taken together, we identified a GPVI-induced multi-phased interactive network of Y- and S/T-protein kinases in human platelets, which is characterized by regulative multisite phosphorylation patterns (Fig. 8). Syk down-regulates SFK activity indicated by decreased Syk pY352. PKC not only activates MAPKs, but also directly phosphorylates Syk S297 and Btk S180 as negative feedback regulation. GPVI-induced granule exocytosis and  $\alpha$ IIb $\beta$ 3 integrin activation are primarily mediated by PKC and involve autocrine ADP release which enhances this process, but additional protein kinases are likely to participate. Acalabrutinib, an approved irreversible Btk/Tec inhibitor, specifically inactivates human blood cell and platelet Btk kinase activity (chemical kinase knock-out) at clinically observed concentrations. There is increasing evidence that not linear signaling pathways, but rather rapid phosphorylation- dephosphorylation cycles of multiple proteins underlie the regulation of complex and important biological functions.<sup>51</sup> Of clinical relevance, the human GPVI signaling network contains multiple Y/S/T protein kinases, which are already targeted by an increasing number of Y- and S/T-protein kinase inhibitors

already used in patients with malignant and/or inflammatory diseases, often in combination. There is a need to enhance the understanding of the GPVI-controlled human platelet signaling network and the possible benefits of novel interventions.

### **What is known about this topic?**

- GPVI is a platelet-specific tyrosine kinase-linked collagen receptor, which signals via the ITAM-containing Fc receptor  $\gamma$ -chain.
- Src-family kinases (SFKs), spleen tyrosine kinase (Syk) and Bruton's tyrosine kinase (Btk) control proximal GPVI-induced tyrosine phosphorylation events.
- Multiple tyrosine as well as serine/threonine protein kinases may play a role in GPVI-induced platelet responses.

### **What does this paper add?**

- Analysis of GPVI-stimulated multisite protein phosphorylation in human platelets demonstrates a multiple phased kinetic pattern and interactions between tyrosine- and serine/threonine protein kinases with reversible activation and feedback regulation.
- After initial tyrosine phosphorylation of GPVI-LAT signalosome components, delayed phases of serine/threonine phosphorylations occur, partially PKC-dependent (Syk<sup>S297</sup>, Btk<sup>S180</sup>, MEK1/2<sup>S217/221</sup>, Erk<sup>T202/Y204</sup>, Akt<sup>S473</sup>) and partially PKC-independent (p38<sup>T180/Y182</sup>, Akt<sup>T308</sup>).
- PKC-dependent protein phosphorylation phases induced by GPVI-mediated Btk activation are required for granule exocytosis and  $\alpha$ IIb $\beta$ 3 integrin activation.

## Author contributions

Conceptualization K.J. and U.W.; methodology P.Z., von U.S., H.L.; data curation P.Z.; formal analysis P.Z. and U.W.; writing—original draft preparation P.Z., U.W. and K.J.; writing—review and editing P.Z., U.W., K.J., F.A.S., A.S., J.W.M.H. and M.J.E.K.; funding and supervision A.S. and K.J.

## Acknowledgements

P.Z. was supported by the European Union's Horizon 2020 research and innovation program under the Marie Skłodowska-Curie grant agreement TICARDIO no. 813409. P.Z. was enrolled in a joint PhD project of the Universities of Maastricht (NL) and Mainz (DE). Figures were created using GraphPad 9.5.1 and Biorender.com.

## Conflicts of Interest

JWMH is a scientific advisor for Synapse Research Institute. The other authors declare no relevant conflicts of interest.

## References

1. Gaertner F, Massberg S. Patrolling the vascular borders: platelets in immunity to infection and cancer. *Nat Rev Immunol* 2019; 19: 747-760
2. Gawaz M, Geisler T, Borst O. Current concepts and novel targets for antiplatelet therapy. *Nature Reviews Cardiology* 2023

3. Jurk K, Kehrel BE. Platelets: Physiology and biochemistry. *Seminars in Thrombosis and Hemostasis* 2005; 31: 381-392
4. Versteeg HH, Heemskerk JWM, Levi M, et al. NEW FUNDAMENTALS IN HEMOSTASIS. *Physiological Reviews* 2013; 93: 327-358
5. Offermanns S. Activation of platelet function through G protein-coupled receptors. *Circulation Research* 2006; 99: 1293-1304
6. Senis YA, Mazharian A, Mori J. Src family kinases: at the forefront of platelet activation. *Blood* 2014; 124: 2013-2024
7. Poole A, Gibbins JM, Turner M, et al. The Fc receptor gamma-chain and the tyrosine kinase Syk are essential for activation of mouse platelets by collagen. *Embo Journal* 1997; 16: 2333-2341
8. Rayes J, Watson SP, Nieswandt B. Functional significance of the platelet immune receptors GPVI and CLEC-2. *J Clin Invest* 2019; 129: 12-23
9. Mocsai A, Ruland J, Tybulewicz VL. The SYK tyrosine kinase: a crucial player in diverse biological functions. *Nat Rev Immunol* 2010; 10: 387-402
10. Singh SP, Dammeijer F, Hendriks RW. Role of Bruton's tyrosine kinase in B cells and malignancies. *Molecular Cancer* 2018; 17
11. Bradshaw JM. The Src, Syk, and Tec family kinases: Distinct types of molecular switches. *Cellular Signalling* 2010; 22: 1175-1184
12. Quek LS, Bolen J, Watson SP. A role for Bruton's tyrosine kinase (Btk) in platelet activation by collagen. *Current Biology* 1998; 8: 1137-1140
13. Ribes A, Oprescu A, Viaud J, et al. Phosphoinositide 3-kinases in platelets, thrombosis and therapeutics. *Biochemical Journal* 2020; 477: 4327-4342

14. Bye AP, Unsworth AJ, Desborough MJ, et al. Severe platelet dysfunction in NHL patients receiving ibrutinib is absent in patients receiving acalabrutinib. *Blood Advances* 2017; 1: 2610-2623
15. Nicolson PLR, Hughes CE, Watson S, et al. Inhibition of Btk by Btk-specific concentrations of ibrutinib and acalabrutinib delays but does not block platelet aggregation mediated by glycoprotein VI. *Haematologica* 2018; 103: 2097-2108
16. Busygina K, Jamasbi J, Seiler T, et al. Oral Bruton tyrosine kinase inhibitors selectively block atherosclerotic plaque-triggered thrombus formation in humans. *Blood* 2018; 131: 2605-2616
17. Series J, Ribes A, Garcia C, et al. Effects of novel Btk and Syk inhibitors on platelet functions alone and in combination in vitro and in vivo. *Journal of Thrombosis and Haemostasis* 2020; 18: 3336-3351
18. Cheung HYF, Moran LA, Sickmann A, et al. Inhibition of Src but not Syk causes weak reversal of GPVI-mediated platelet aggregation measured by light transmission aggregometry. *Platelets* 2022; 33: 1293-1300
19. Byrd JC, Harrington B, O'Brien S, et al. Acalabrutinib (ACP-196) in Relapsed Chronic Lymphocytic Leukemia. *New England Journal of Medicine* 2016; 374: 323-332
20. Series J, Ribes A, Garcia C, et al. Effects of novel Btk and Syk inhibitors on platelet functions alone and in combination in vitro and in vivo. *Journal of Thrombosis and Haemostasis* 2020; 18: 3336-3351
21. Tullemans BME, Karel MFA, Léopold V, et al. Comparison of inhibitory effects of irreversible and reversible Btk inhibitors on platelet function. *EJHaem* 2021; 2: 685-699

22. Babur O, Melrose AR, Cunliffe JM, et al. Phosphoproteomic quantitation and causal analysis reveal pathways in GPVI/ITAM-mediated platelet activation programs. *Blood* 2020; 136: 2346-2358
23. Zheng TJ, Lofurno ER, Melrose AR, et al. Assessment of the effects of Syk and BTK inhibitors on GPVI-mediated platelet signaling and function. *American Journal of Physiology-Cell Physiology* 2021; 320: C902-C915
24. Beck F, Geiger J, Gambaryan S, et al. Temporal quantitative phosphoproteomics of ADP stimulation reveals novel central nodes in platelet activation and inhibition. *Blood* 2017; 129: e1-e12
25. Makhoul S, Trabold K, Gambaryan S, et al. cAMP- and cGMP-elevating agents inhibit GPIb alpha-mediated aggregation but not GPIb alpha-stimulated Syk activation in human platelets. *Cell Communication and Signaling* 2019; 17
26. Makhoul S, Dorschel S, Gambaryan S, et al. Feedback Regulation of Syk by Protein Kinase C in Human Platelets. *International Journal of Molecular Sciences* 2020; 21
27. Makhoul S, Kumm E, Zhang P, et al. The Serine/Threonine Protein Phosphatase 2A (PP2A) Regulates Syk Activity in Human Platelets. *Int J Mol Sci* 2020; 21
28. Zhang PY, Solari FA, Heemskerk JWM, et al. Differential Regulation of GPVI-Induced Btk and Syk Activation by PKC, PKA and PP2A in Human Platelets. *International Journal of Molecular Sciences* 2023; 24
29. Gilio K, Harper MT, Cosemans J, et al. Functional Divergence of Platelet Protein Kinase C (PKC) Isoforms in Thrombus Formation on Collagen. *Journal of Biological Chemistry* 2010; 285: 23408-23417

30. Fernández DI, Provenzale I, Cheung HYF, et al. Ultra-high-throughput Ca<sup>2+</sup> assay in platelets to distinguish ITAM-linked and G-protein-coupled receptor activation. *iScience* 2022; 25: 103718
31. Cheung HYF, Zou J, Tantiwong C, et al. High-throughput assessment identifying major platelet Ca<sup>2+</sup> entry pathways via tyrosine kinase-linked and G protein-coupled receptors. *Cell Calcium* 2023; 112: 102738
32. Dohmann M, Makhoul S, Gross K, et al. CD36-fibrin interaction propagates FXI-dependent thrombin generation of human platelets. *Faseb Journal* 2020; 34: 9337-9357
33. Moroi AJ, Watson SP. Impact of the PI3-kinase/Akt pathway on ITAM and hemITAM receptors: Haemostasis, platelet activation and antithrombotic therapy. *Biochemical Pharmacology* 2015; 94: 186-194
34. Patel P, Naik UP. Platelet MAPKs-a 20+ year history: What do we really know? *J Thromb Haemost* 2020
35. Reilly MP, Sinha U, Andre P, et al. PRT-060318, a novel Syk inhibitor, prevents heparin-induced thrombocytopenia and thrombosis in a transgenic mouse model. *Blood* 2011; 117: 2241-2246
36. Perrella G, Montague SJ, Brown HC, et al. Role of Tyrosine Kinase Syk in Thrombus Stabilisation at High Shear. *International Journal of Molecular Sciences* 2022; 23: 493
37. Joshi S, Whiteheart SW. The nuts and bolts of the platelet release reaction. *Platelets* 2017; 28: 129-137
38. Manne BK, Xiang SC, Rondina MT. Platelet secretion in inflammatory and infectious diseases. *Platelets* 2017; 28: 155-164



39. Hechler B, Gachet C. Purinergic Receptors in Thrombosis and Inflammation. *Arteriosclerosis Thrombosis and Vascular Biology* 2015; 35: 2307-2315
40. Senis YA. Protein-tyrosine phosphatases: a new frontier in platelet signal transduction. *Journal of Thrombosis and Haemostasis* 2013; 11: 1800-1813
41. Jurk K, Walter U. New Insights into Platelet Signalling Pathways by Functional and Proteomic Approaches. *Hamostaseologie* 2019; 39: 140-151
42. Kumm EJ, Pagel O, Gambaryan S, et al. The Cell Cycle Checkpoint System MAST(L)-ENSA/ARPP19-PP2A is Targeted by cAMP/PKA and cGMP/PKG in Anucleate Human Platelets. *Cells* 2020; 9
43. Kunapuli SP, Tsygankov AY. TULA-Family Regulators of Platelet Activation. *International Journal of Molecular Sciences* 2022; 23: 14910
44. Burkhart JM, Vaudel M, Gambaryan S, et al. The first comprehensive and quantitative analysis of human platelet protein composition allows the comparative analysis of structural and functional pathways. *Blood* 2012; 120: e73-82
45. Dinur-Schejter Y, Zaidman I, Mor-Shaked H, et al. The Clinical Aspect of Adaptor Molecules in T Cell Signaling: Lessons Learnt From Inborn Errors of Immunity. *Frontiers in Immunology* 2021; 12
46. Watanabe D, Hashimoto S, Ishiai M, et al. Four tyrosine residues in phospholipase C-gamma 2, identified as Btk-dependent phosphorylation sites, are required for B cell antigen receptor-coupled calcium signaling. *J Biol Chem* 2001; 276: 38595-38601
47. Kang SW, Wahl MI, Chu J, et al. PKCbeta modulates antigen receptor signaling via regulation of Btk membrane localization. *Embo j* 2001; 20: 5692-5702

48. Bohnenberger H, Oellerich T, Engelke M, et al. Complex phosphorylation dynamics control the composition of the Syk interactome in B cells. *Eur J Immunol* 2011; 41: 1550-1562
49. Mohammad DK, Nore BF, Gustafsson MO, et al. Protein kinase B (AKT) regulates SYK activity and shuttling through 14-3-3 and importin. *International Journal of Biochemistry & Cell Biology* 2016; 78: 63-74
50. Jakubowski JA, Payne CD, Weerakkody GJ, et al. Dose-Dependent Inhibition of Human Platelet Aggregation by Prasugrel and its Interaction With Aspirin in Healthy Subjects. *Journal of Cardiovascular Pharmacology* 2007; 49: 167-173
51. Gelens L, Qian JB, Bollen M, et al. The Importance of Kinase-Phosphatase Integration: Lessons from Mitosis. *Trends in Cell Biology* 2018; 28: 6-21

**Fig. 1 Time-dependent phosphorylation of multiple protein kinases and substrates in human platelets induced by convulxin.** Washed human platelets were stimulated with 50 ng/mL convulxin at 37 °C under stirring, and activation was stopped after 0, 10, 30, 60, 120 or 300 s with Lämmli buffer. (A) Representative blots showing convulxin-stimulated protein phosphorylation of: Syk S297, Syk Y352, Syk Y525/526, LAT Y220, Btk S180, Btk Y223, Btk Y551, PLC $\gamma$ 2 Y759, PLC $\gamma$ 2 Y1217, MEK1/2 S217/221, Erk1/2 T202/Y204 and p38 T180/Y182. Antibodies against total Syk, total Btk, total PLC $\gamma$ 2, total MEK1/2 and  $\alpha$ -actinin were used as loading controls. (B) The phosphorylation of Syk (i), Btk (ii), LAT (iii), PLC $\gamma$ 2 (iv), MEK1/2 S217/221 (v), Erk1/2 T202/Y204 and p38 (vi) was analyzed, and compared with staining for total Syk, total Btk,  $\alpha$ -actinin, total PLC $\gamma$ 2, total MEK1/2 and  $\alpha$ -actinin, respectively. Quantitative data are represented as mean  $\pm$  SD from three independent experiments with platelets from three healthy donors (n = 3). \*\*\*\* P <

0.0001, \*\*\*  $p < 0.001$ , \*\*  $p < 0.01$ , \*  $p < 0.05$ , 0 s versus other time points of convulxin-treated platelets.

**Fig. 2 General suppression of convulxin-induced phosphorylation by Syk inhibitor PRT-060318 except for Syk Y352.** Washed human platelets were treated with 0.1% DMSO or 1  $\mu\text{M}$  PRT-060318 for 5 min, prior to stimulation with 50 ng/mL convulxin under stirring, and activation was stopped after 0, 10, 30, 60, 120 or 300 s with Lämmli buffer. (A) Representative blots show convulxin-stimulated protein phosphorylation with or without PRT-060318 preincubation including Syk S297, Syk Y352, Syk Y525/526, LAT Y220, Btk S180, Btk Y223, Btk Y551, PLCy2 Y759, PLCy2 Y1217, MEK1/2 S217/221, Erk1/2 T202/Y204 and p38 T180/Y182. Antibodies against total Syk, total Btk, total PLCy2, total MEK1/2 and  $\alpha$ -actinin were used as loading controls. (B) Phosphorylation of Syk (i-iii), Btk (iv-vi), LAT (vii), PLCy2 (viii-ix), MEK1/2 S217/221 (x), Erk1/2 T202/Y204 and p38 T180/Y182 (xi-xii) was analyzed, and compared with total Syk, total Btk,  $\alpha$ -actinin, total PLCy2, total MEK1/2 and  $\alpha$ -actinin, respectively. Quantified data are mean  $\pm$  SD from three independent experiments with platelets from three healthy donors ( $n = 3$ ). \*\*\*\* $P < 0.0001$ , \*\*\* $p < 0.001$ , \*\* $p < 0.01$ , \* $p < 0.05$ , DMSO versus PRT-060318-treated platelets in response to convulxin at the same time points. Note, original blots of convulxin-induced protein phosphorylation are identical to those of Fig 1.

**Fig. 3 Partial suppression of convulxin-induced phosphorylation by Btk inhibitor acalabrutinib, but not Syk Y352, Y525/526, LAT Y220 and Btk Y551.** Washed platelets were treated with 0.1% DMSO or 5  $\mu\text{M}$  acalabrutinib for 5 min, prior to stimulation with 50 ng/mL convulxin under stirring, and activation was

stopped after 0, 10, 30, 60, 120 or 300 s with Lämmli buffer. (A) Representative blots showing convulxin-stimulated protein phosphorylation with or without acalabrutinib preincubation: Syk S297, Syk Y352, Syk Y525/526, LAT Y220, Btk S180, Btk Y223, Btk Y551, PLCy2 Y759, PLCy2 Y1217, MEK1/2 S217/221, Erk1/2 T202/Y204 and p38 T180/Y182. Antibodies against total Syk, total Btk, total PLCy2, total MEK1/2 and  $\alpha$ -actinin were used as loading controls. (B) Phosphorylation of Syk (i-iii), Btk (iv-vi), LAT (vii), PLCy2 (viii-ix), MEK1/2 S217/221 (x), Erk1/2 T202/Y204 and p38 T180/Y182 (xi-xii) was analyzed and compared with total Syk, total Btk,  $\alpha$ -actinin, total PLCy2, total MEK1/2 and  $\alpha$ -actinin, respectively. Quantitative data are represented as the mean  $\pm$  SD from three independent experiments with platelets from three healthy donors (n = 3). \*\*\*\*P < 0.0001, \*\*\*p < 0.001, \*\*p < 0.01, \*p < 0.05, DMSO versus acalabrutinib-treated platelets in response to convulxin at the same time points.

**Fig. 4 Differential suppression of convulxin-induced S/T phosphorylation by PKC inhibitor GF109203X, leaving p38 T180/Y182 unchanged.** Washed human platelets were treated with 0.1 % DMSO or 5  $\mu$ M GF109203X for 5 min at 37 °C prior to stimulation with 50 ng/mL convulxin under stirring, and stopped after 0, 10, 30, 60, 120 or 300 s with Lämmli buffer. (A) Representative blots showing convulxin-stimulated protein phosphorylation with(out) GF109203X preincubation for: Syk S297, Syk Y352, Syk Y525/526, LAT Y220, Btk S180, Btk Y223, Btk Y551, PLCy2 Y759, PLCy2 Y1217, MEK1/2 S217/221, Erk1/2 T202/Y204 and p38 T180/Y182. Antibodies against total Syk, total Btk, total PLCy2, total MEK1/2 or  $\alpha$ -actinin were used as loading controls. (B) Phosphorylation of Syk (i-iii), Btk (iv-vi), LAT (vii), PLCy2 (viii-ix), MEK1/2 S217/221 (x), Erk1/2 T202/Y204 and p38 T180/Y182 (xi-xii)

was analyzed and compared with total Syk, total Btk,  $\alpha$ -actinin, total PLC $\gamma$ 2, total MEK1/2 and  $\alpha$ -actinin, respectively. Quantitative data are represented as mean  $\pm$  SD from three independent experiments with platelets from three donors (n = 3). \*\*\*\*P < 0.0001, \*\*\*p < 0.001, \*\*p < 0.01, \*p < 0.05, DMSO versus GF109203X-treated platelets in response to convulxin at the same time points.

**Fig. 5 Acalabrutinib, not GFX109203X, suppresses convulxin-induced Ca<sup>2+</sup> mobilization in platelets.** Fura-2-loaded human platelets were stimulated by 50 ng/mL convulxin, after preincubation with acalabrutinib or GF109203X. Calibrated intracellular Ca<sup>2+</sup> rises were recorded for 10 min in 96-wells plates at 37 °C. Area under the curve (AUC) within 10 min of convulxin-stimulated intracellular Ca<sup>2+</sup> rises was normalized to 100%. Shown are normalized AUC of intracellular Ca<sup>2+</sup> rises in response to convulxin in the presence of acalabrutinib (A) or GF109203X (B). Mean  $\pm$  SD from at least three independent experiments with platelets from healthy donors (n  $\geq$  3). \*\*\*\*P < 0.0001, \*\*\*p < 0.001, \*\*p < 0.01, \*p < 0.05, DMSO versus acalabrutinib or GF109203X-treated platelets in response to convulxin.

**Fig. 6 Inhibitors of Syk, Btk and PKC strongly down-regulate convulxin-induced platelet granule secretion and  $\alpha$ IIb $\beta$ 3 integrin activation.** Washed platelets were pretreated with 0.1% DMSO, 1  $\mu$ M PRT, 1-5  $\mu$ M acalabrutinib, 1-5  $\mu$ M GF109203X for 5 min, before stimulation with 50 ng/mL convulxin for 5 min. Surface expression of CD63 (A) and CD62P (B), and FITC PAC-1 antibody binding (C) were assessed by flow cytometry. The mean fluorescence intensity (MFI) in control condition, established when the convulxin was administered with a vehicle medium and no inhibitor, served as 100%. Subsequent analysis of inhibitor effects entailed

expressing these effects as percentage changes relative to this established control condition. Percentage data are shown, with convulxin condition normalized to 100%. Mean  $\pm$  SD from four donors (n = 4). \*\*\*\*P < 0.0001, \*\*\*p < 0.001, \*\*p < 0.01, \*p < 0.05, indicated inhibitor versus DMSO.

**Fig. 7 The P2Y<sub>12</sub> receptor blocker AR-C669931 suppresses convulxin-induced platelet granule secretion and  $\alpha$ IIb $\beta$ 3 integrin activation.** Washed platelets were pretreated with 0.1% DMSO, 2.5-1000 nM AR-C669931 for 15 min before stimulation with 50 ng/mL convulxin for 5 min. Surface expression of CD63 (A) and CD62P (B) and FITC PAC-1 antibody binding (C) were analyzed by flow cytometry. The control condition, established when the convulxin was administered with a vehicle medium and no inhibitor, served as 100%. Subsequent analysis of inhibitor effects entailed expressing these effects as percentage changes relative to this established control condition. Results are shown as %; stimulation by convulxin was normalized to 100%. Mean  $\pm$  SD from three healthy donors (n = 3). \*\*\*\*P < 0.0001, \*\*\*p < 0.001, \*\*p < 0.01, \*p < 0.05, DMSO versus AR-C669931-treated platelets in response to convulxin.

**Fig. 8 Model showing bi-directional links between GPVI signalosome effects and platelet functions.** Central (green background area) is the signalosome network of multiple tyrosine kinases (SFK, Syk, Btk) and serine/threonine kinases (PKC, MEK1/2, Erk1/2, p38, Akt), which are (in)activated by multisite phosphorylation changes. The phosphorylation of PLC $\gamma$ 2, MEK1/2 and Erk1/2, similarly as platelet functional responses, is Btk- and PKC-dependent, which includes mechanisms of feedback inhibition (Syk S297 and Btk S180

phosphorylation) and feedforward enhancement (P2Y<sub>12</sub> stimulation by secreted ADP). Indicated pathways were revealed by specific inhibition of Syk, Btk or PKC. While this model represents the data obtained, additional proteins, phospho-sites and alternative signaling pathways can be involved as well. For further details, see text.





# Multi-phased kinetics and interaction of protein kinase signaling in glycoprotein VI-induced platelet $\alpha\text{IIb}\beta\text{3}$ integrin activation and degranulation

Pengyu Zhang<sup>1, 2, 3</sup>, Saskia von Ungern-Sternberg<sup>1</sup>, Luisa Hastenplug<sup>1</sup>, Fiorella A. Solari<sup>2</sup>, Albert Sickmann<sup>2, 5, 6</sup>, Marijke J. E. Kuijpers<sup>3</sup>, Johan W. M. Heemskerk<sup>3, 4</sup>, Ulrich Walter<sup>1\*</sup> and Kerstin Jurk<sup>1\*</sup>

1. Center for Thrombosis and Hemostasis (CTH), University Medical Center of the Johannes Gutenberg University Mainz, 55131 Mainz, Germany
2. Leibniz Institut für Analytische Wissenschaften-ISAS-e.V., 44139 Dortmund, Germany
3. Department of Biochemistry, Cardiovascular Research Institute Maastricht (CARIM), Maastricht University, Maastricht, The Netherlands
4. Synapse Research Institute Maastricht, Koningin Emmalein 76217 KD Maastricht, The Netherlands
5. Medizinische Fakultät, Medizinisches Proteom-Center, Ruhr-Universität Bochum, 44780 Bochum, Germany
6. Department of Chemistry, College of Physical Sciences, University of Aberdeen, Aberdeen AB25 2ZD, UK

## Supplementary materials

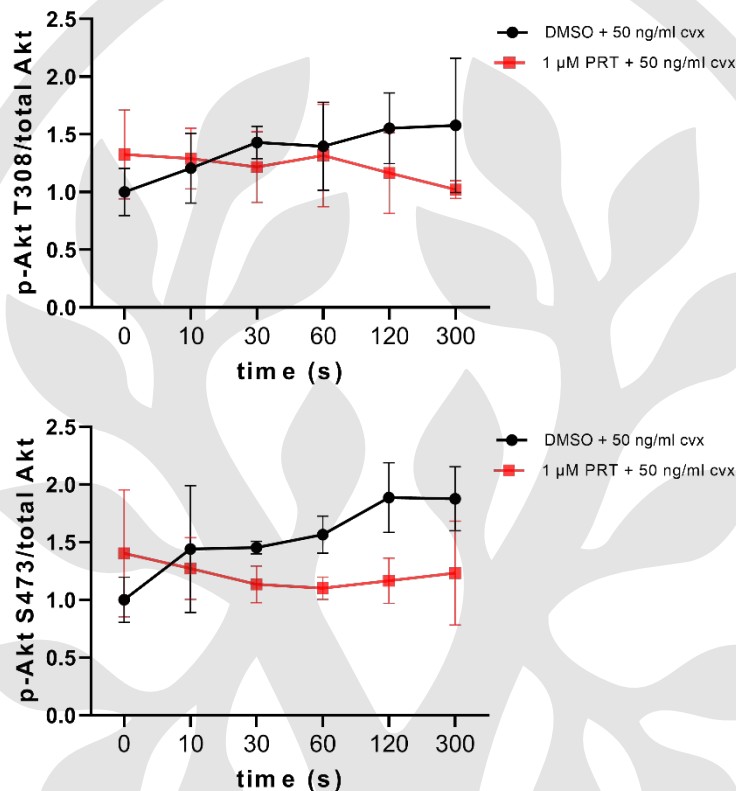
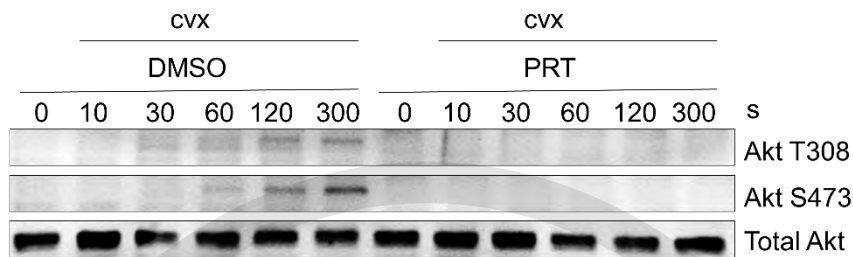
**Supplementary Table 1 Summary of GPVI-induced protein phosphorylation sites and kinase dependency in human platelets. \*Summary data from this study (Fig. 1-4), \*\*general protein kinase information available by databases.**

Phospho-	GPVI-induced phospho-	Phosphorylated	Effect on protein
----------	-----------------------	----------------	-------------------

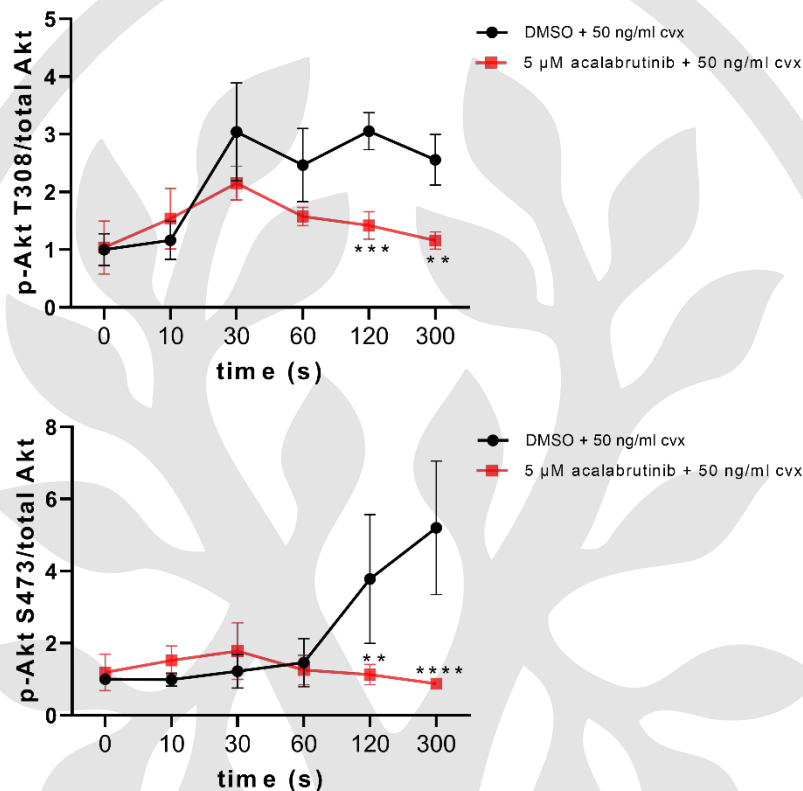
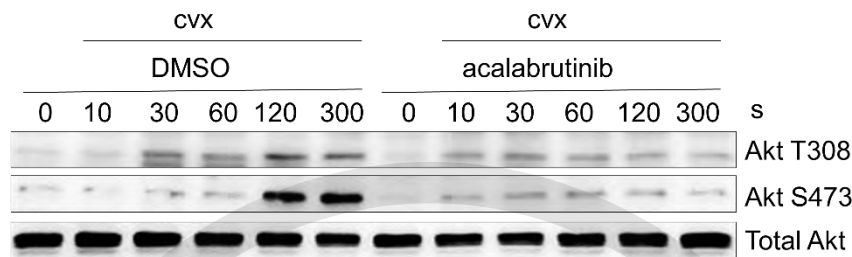
site	rylation dependent on *				by **	kinase activity**
	SFK	Syk	Btk	PKC		
Syk Y352	+	-	-	-	SFK (Lyn)	essential for Syk activation
Syk Y525/526	+	+	-	-	Syk (SFK, Lyn)	indicates Syk activity (autophosphorylation)
Syk S297	+	+	+	+	PKC ( $\alpha$ , $\beta$ )	attenuates Syk activity
Btk Y551	+	+	-	-	Syk (SFKs)	essential for Btk activation
Btk Y223	+	+	+	-	Btk	indicates Btk activity (autophosphorylation)
Btk S180	+	+	+	+	PKC ( $\alpha$ , $\beta$ )	attenuates Btk activity
LAT Y220	+	+	-	-	Syk	increased SH2-adapter function
PLCy2 Y759	+	+	+	-	Btk	activates PLCy2
PLCy2 Y1217	+	+	+	-	Btk	activates PLCy2
MEK1/2 S217/S221	+	+	+	+	A/B/C-RAF	Indicates MEK1/2 activity
Erk1/2 T202/Y204	+	+	+	+	MEK1/2, other?	indicates Erk1/2 activity
p38	+	+	+	-	MEK3/4, other?	indicates p38 activity

T180/Y182						
Akt T308	+	+	+	-	PDK1	indicates Akt activity
Akt S473	+	+	+	+	mTOR	Indicates Akt activity

Given protein Y/S/T phosphorylation sites are well documented for different cell types including platelets (<https://www.phosphosite.org>, <http://www.phosphonet.ca>, <http://www.kinaset.net>). Dependency on protein kinases is summarized as revealed in the present study (Fig. 1-4) and combined with information provided by PhosPhositePlus. Note that protein phosphorylation occurs in cascades, so that a given phospho-site can also indirectly (via another kinase) be affected by the given protein kinase.

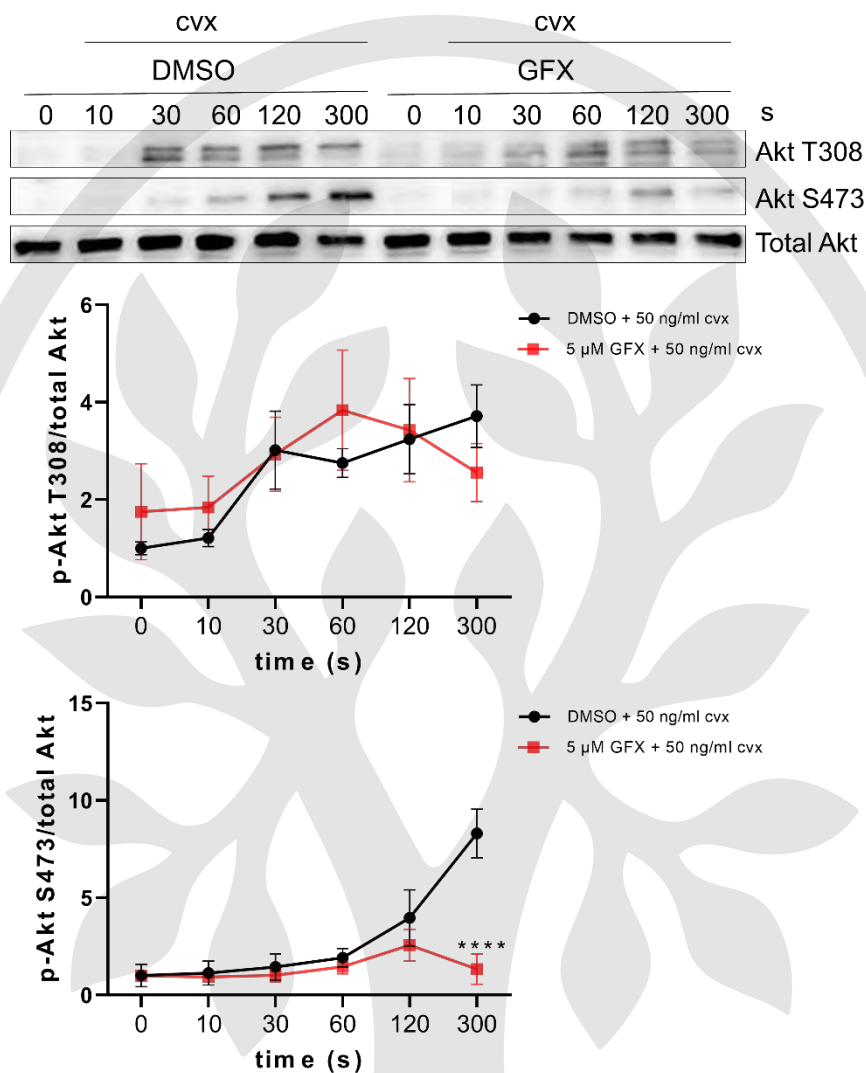


**Supplementary Fig. 1 Syk inhibitor PRT-060318 suppresses convulxin-induced Akt T308 and Akt S473 phosphorylation.** Platelets were treated with 0.1% DMSO or 1  $\mu$ M PRT-060318 for 5 min at 37  $^{\circ}$ C prior to stimulation with 50 ng/mL convulxin under stirring, and stopped after 0, 10, 30, 60, 120 or 300 s with Lämmli buffer. (A) Representative blots of convulxin-stimulated Akt phosphorylation in the presence of PRT-060318. Antibody against total Akt was used as loading control. (B) Phosphorylation of Akt T308 and Akt S473 was analyzed and compared with total Akt. Quantitative data are represented as mean  $\pm$  SD from independent experiments with platelets from three healthy donors ( $n = 3$ ), DMSO versus PRT-060318-treated platelets in response to convulxin



**Supplementary Fig. 2 Btk inhibitor acalabrutinib abolishes convulxin-induced Akt T308 and Akt S473 phosphorylation.** Platelets were treated with 0.1% DMSO or 5  $\mu$ M acalabrutinib for 5 min, followed by 50 ng/mL convulxin under stirring. Reactions were stopped after 0, 10, 30, 60, 120 or 300 s with Lämmli buffer. (A) Representative blots of convulxin-induced Akt phosphorylation in the presence of acalabrutinib. Antibody against total Akt was used as loading control. (B) Phosphorylation of Akt T308 and Akt S473 was analyzed and compared with total Akt. Quantitative data are represented as mean  $\pm$  SD from independent experiments with platelets from three healthy donors ( $n = 3$ ), \*\*\*\* $p < 0.0001$ , \*\*\* $p < 0.001$ , \*\* $p <$

0.01, \* $p < 0.05$ , DMSO versus acalabrutinib-treated platelets in response to convulxin.



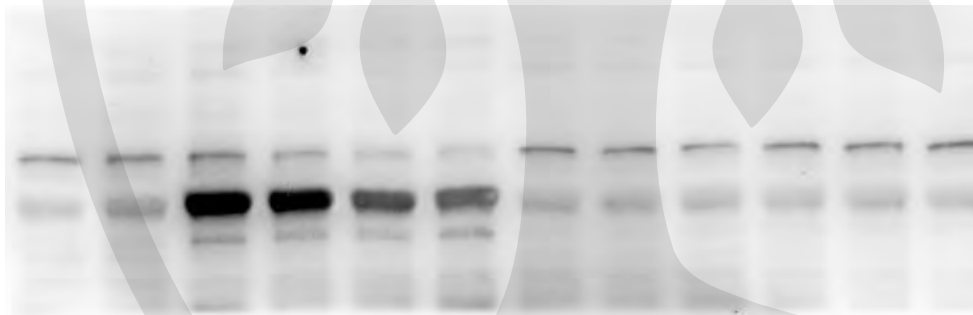
**Supplementary Fig. 3 PKC inhibitor GF109203X strongly reduces convulxin-induced Akt S473 but not T308 phosphorylation.** Washed human platelets were treated with 0.1% DMSO or 5 μM GF109203X for 5 min at 37 °C prior to stimulation with 50 ng/mL convulxin with stirring, and stopped after 0, 10, 30, 60, 120 or 300 s with Lämmli buffer. (A) Representative blots of convulxin-induced Akt phosphorylation in the presence of GF109203X. Antibody against total Akt was used as loading control. (B) Phosphorylation of Akt T308 and Akt S473 was analyzed and compared with total Akt. Quantitative data are represented as mean ± SD from

independent experiments with platelets from three healthy donors ( $n = 3$ ), \*\*\*\* $p < 0.0001$ , \*\*\* $p < 0.001$ , \*\* $p < 0.01$ , \* $p < 0.05$ , DMSO versus GFX109203X-treated platelets in response to convulxin.

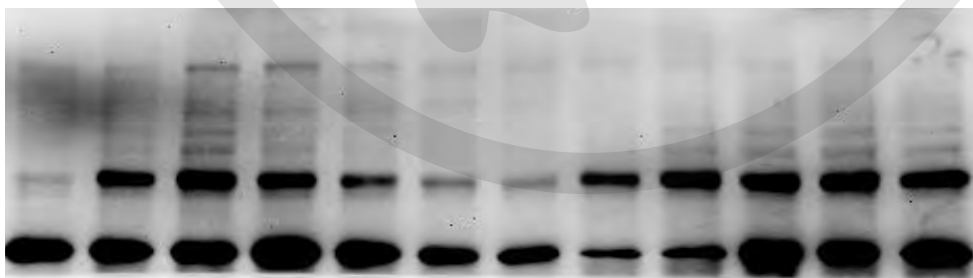
**Original blots:**

Fig 1 and Fig 2

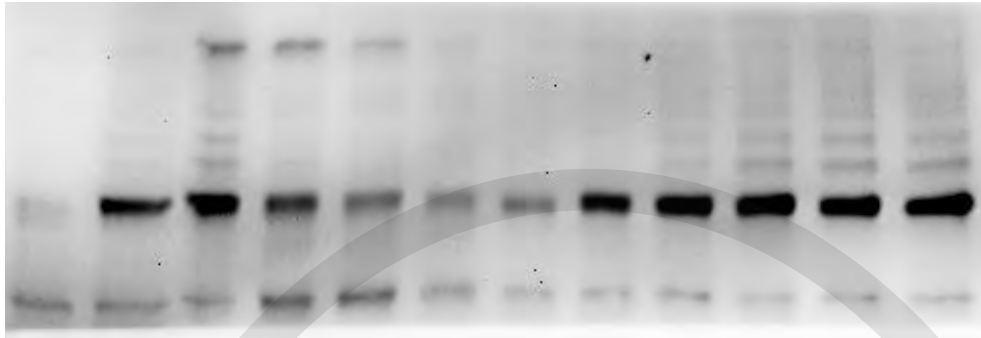
Syk S297



Syk Y352



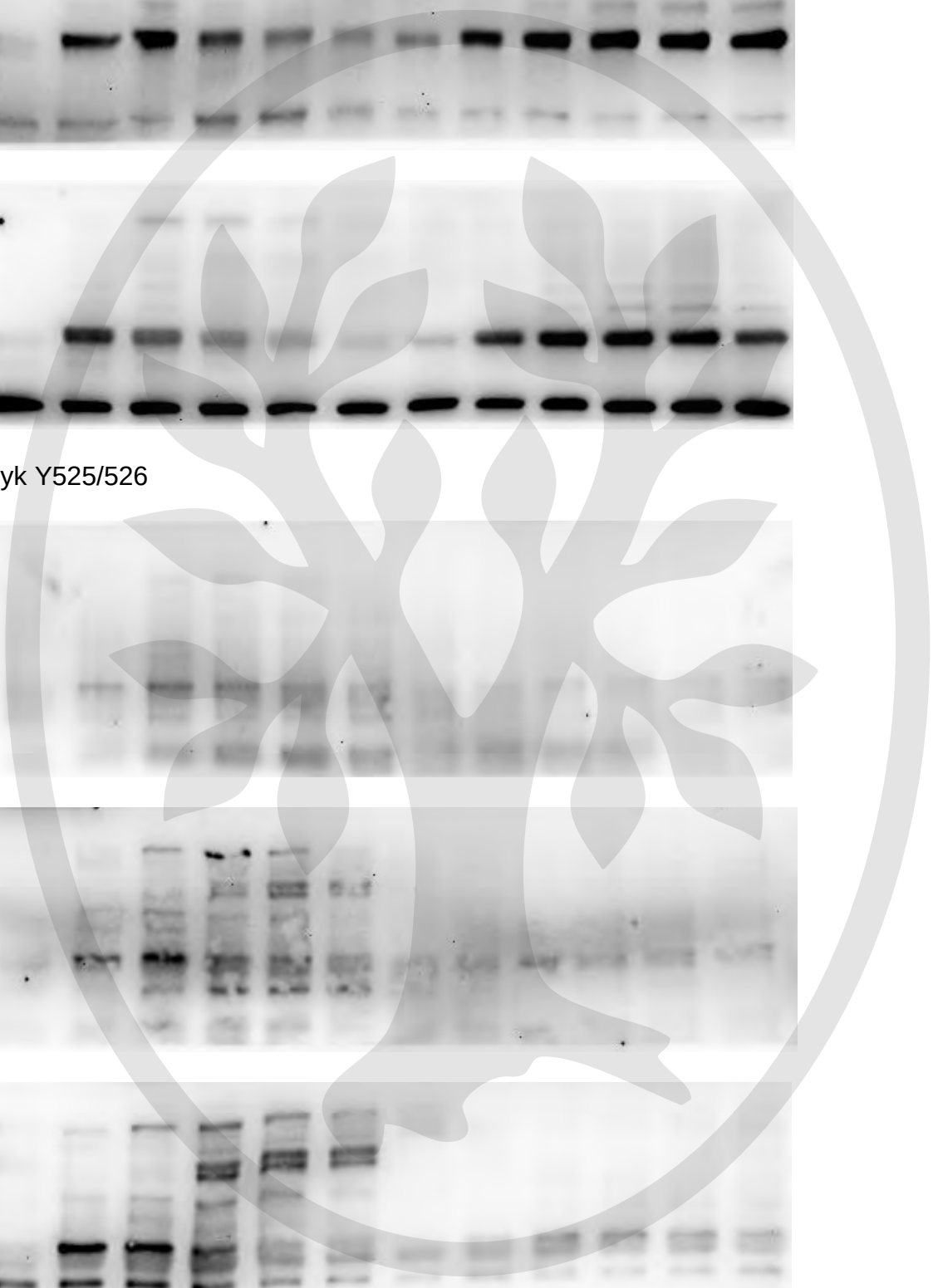


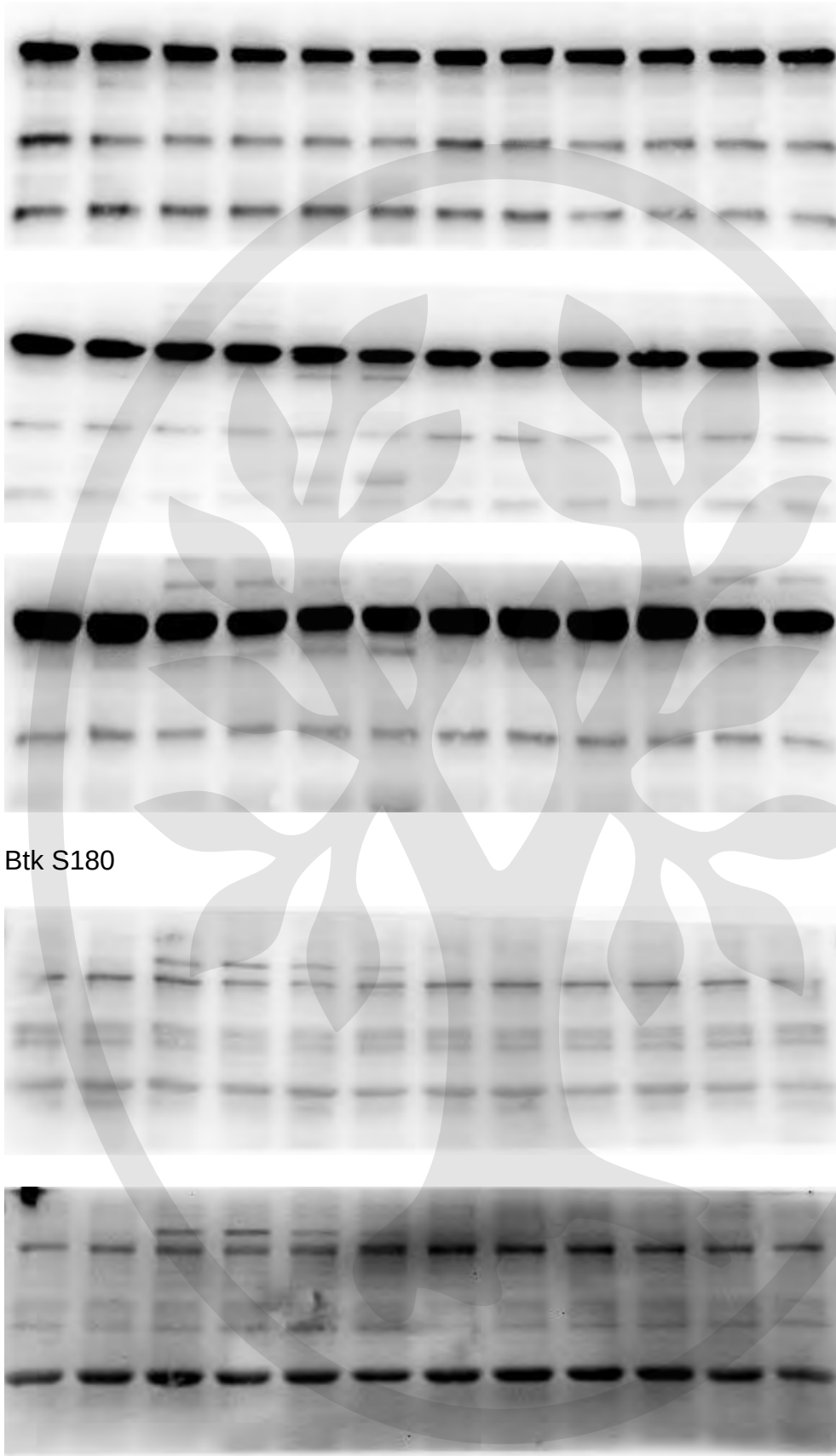


Syk Y525/526

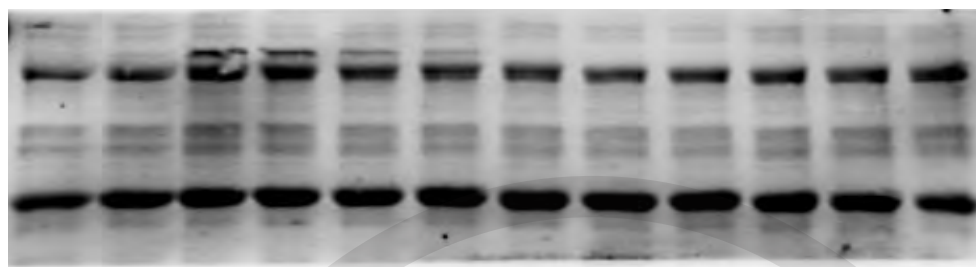


Total Syk

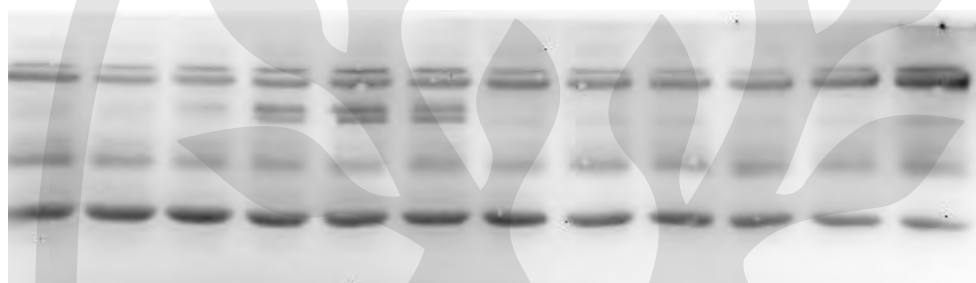
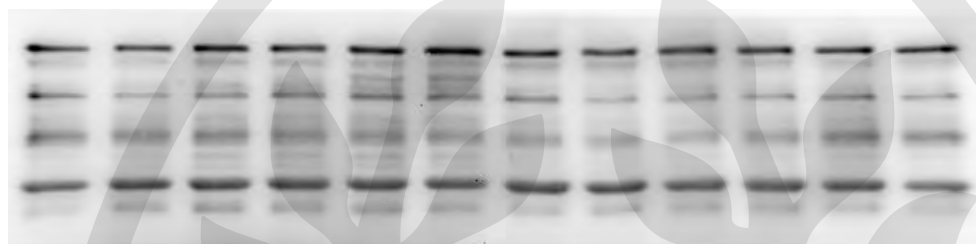




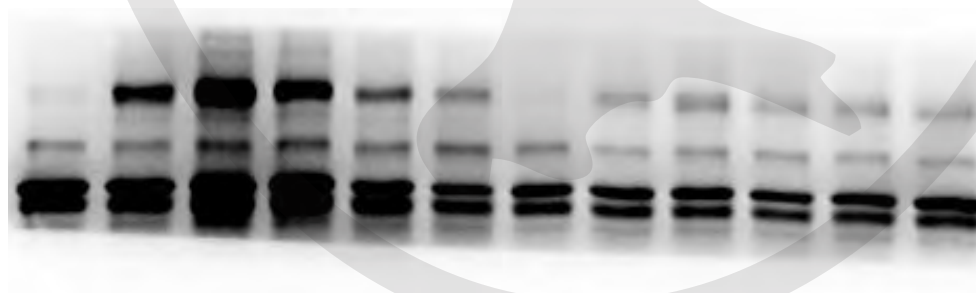
Btk S180

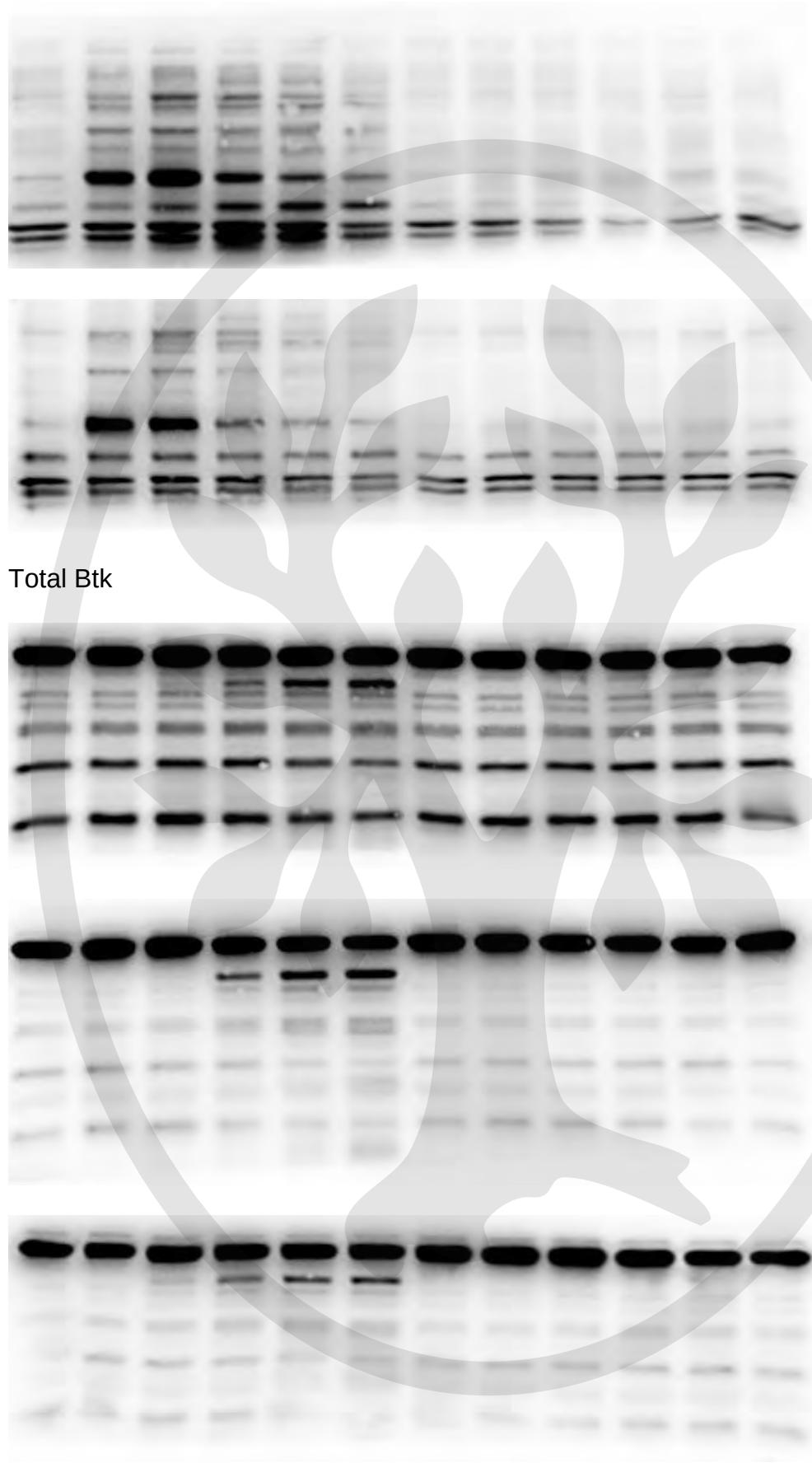


Btk Y223



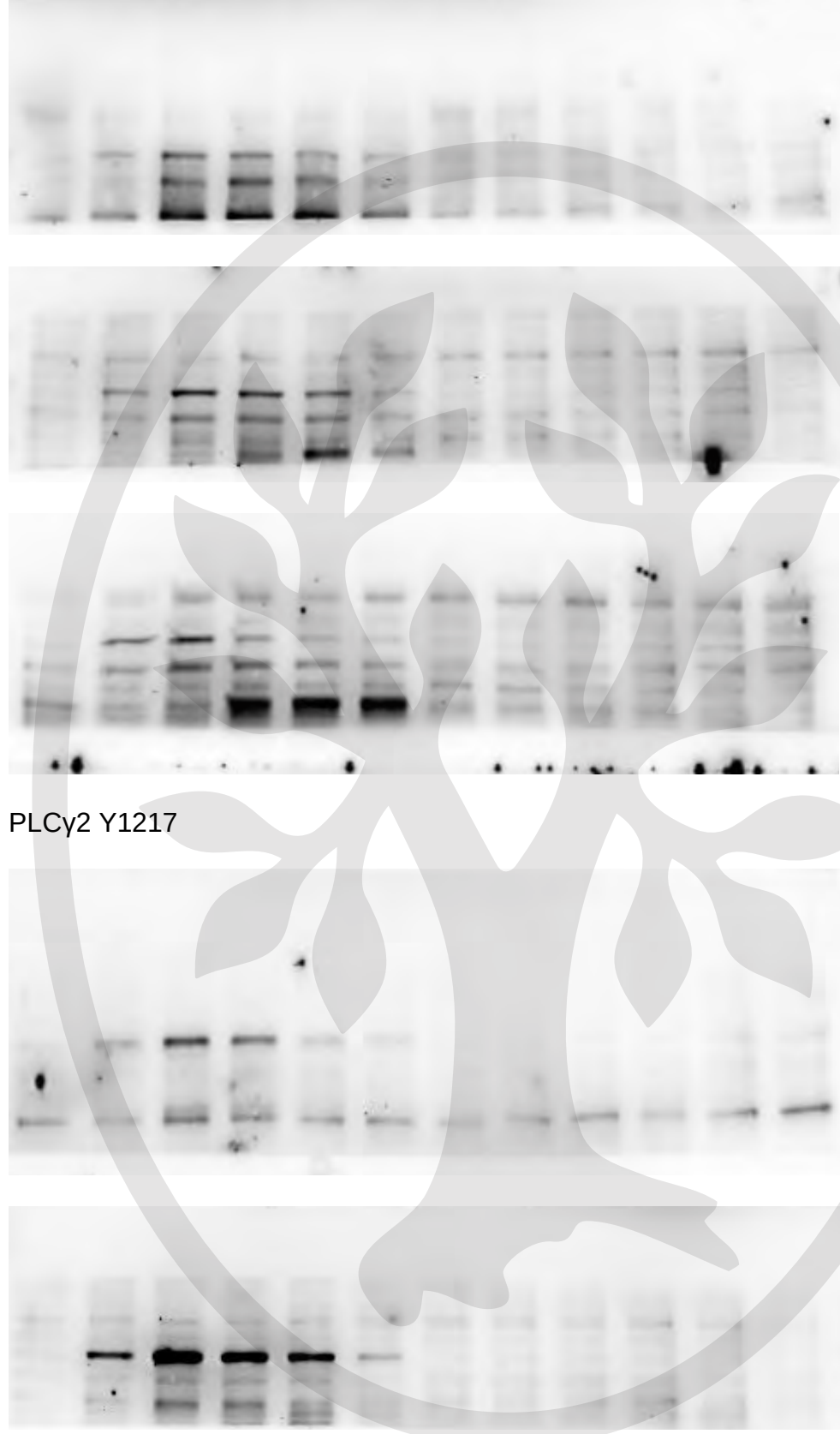
Btk Y551





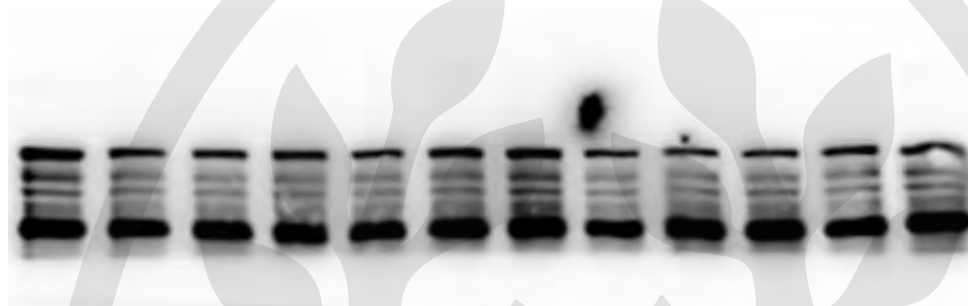
Total Btk

PLCy2 Y759

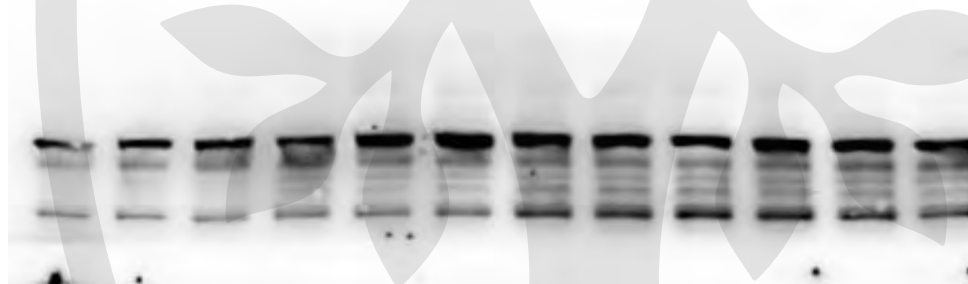
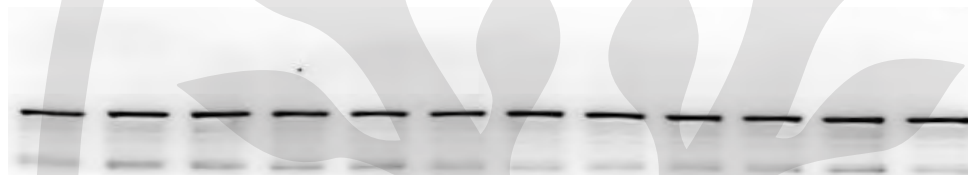


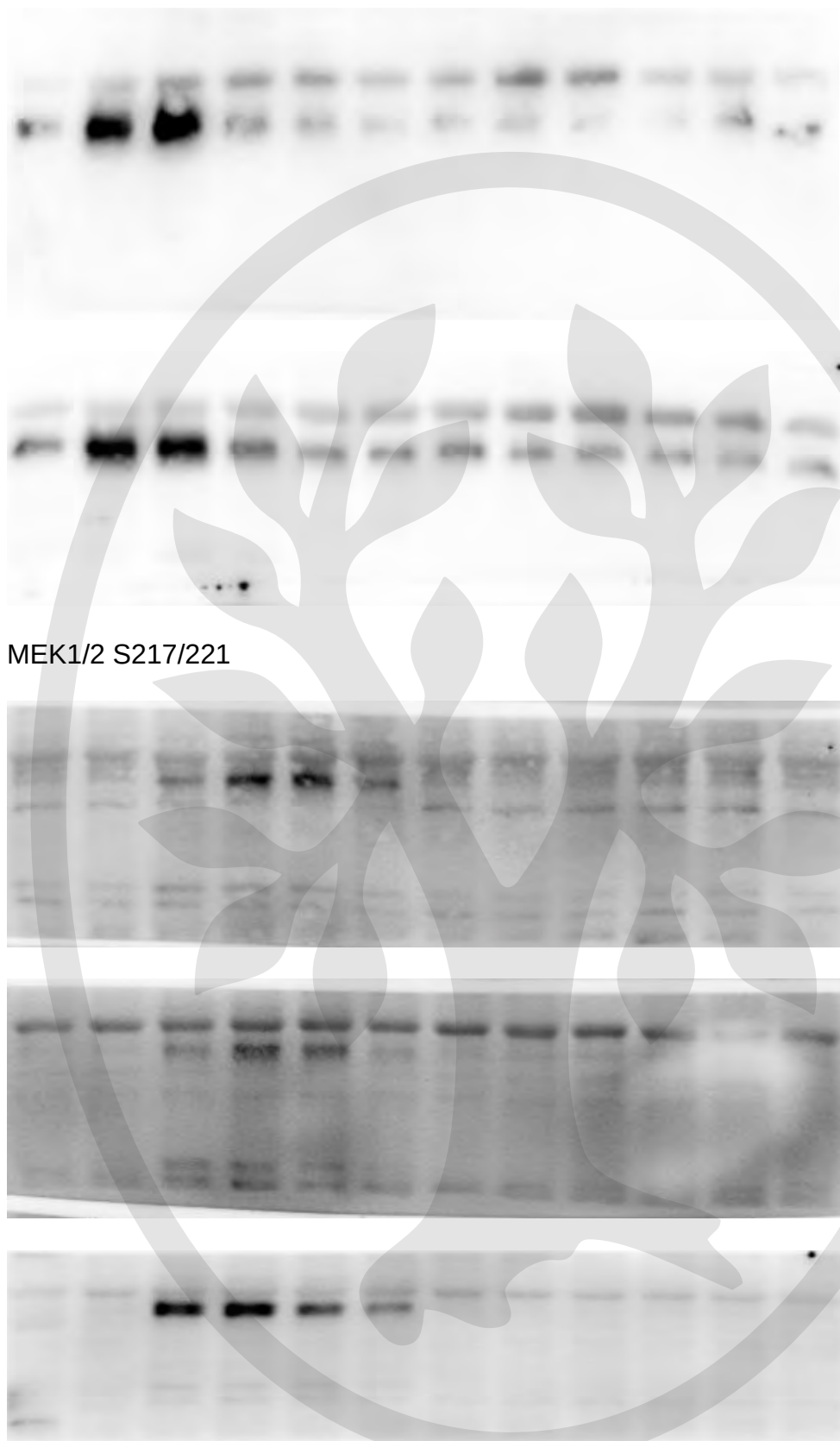


Total PLCy2



LAT Y220

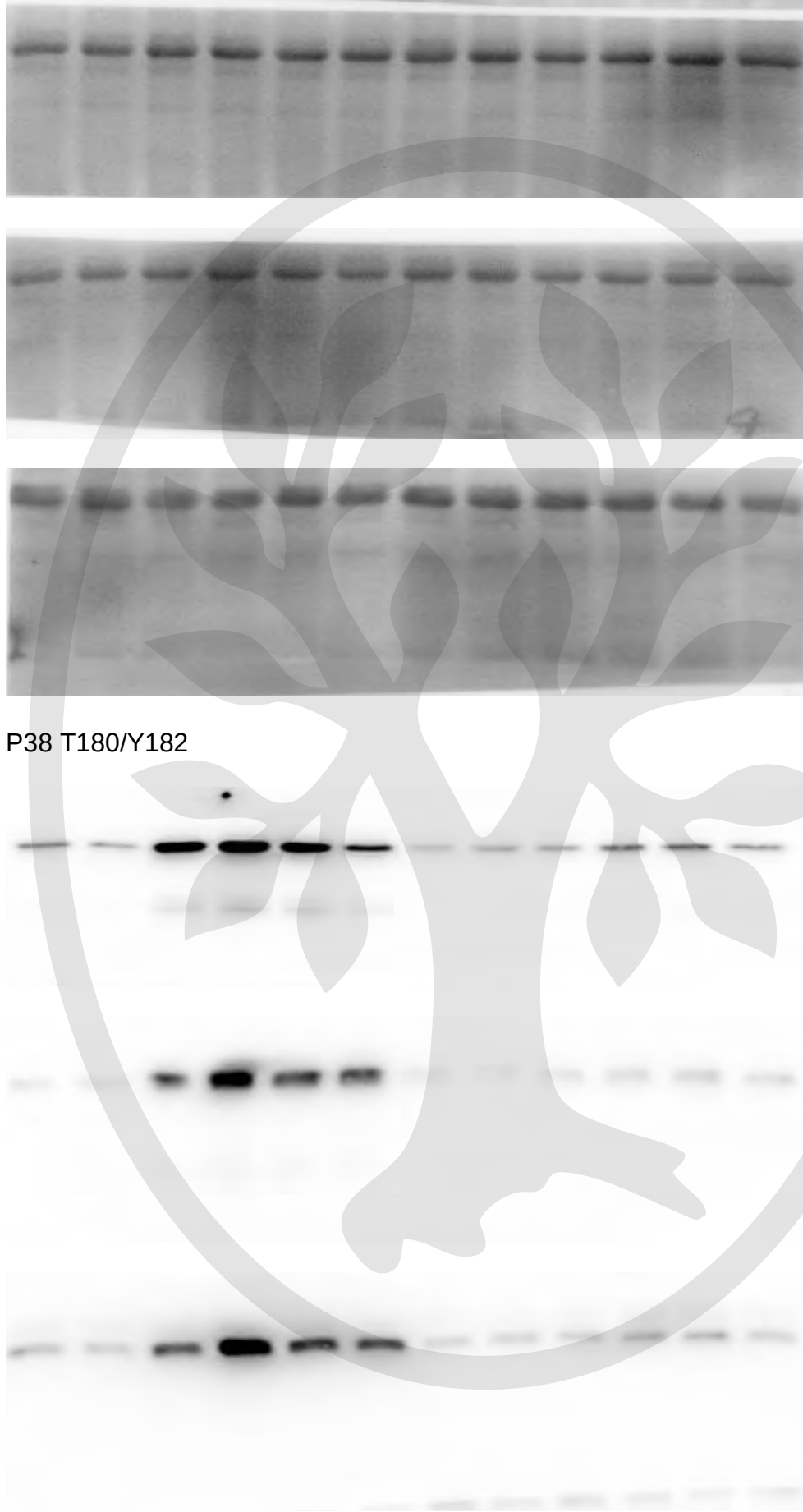


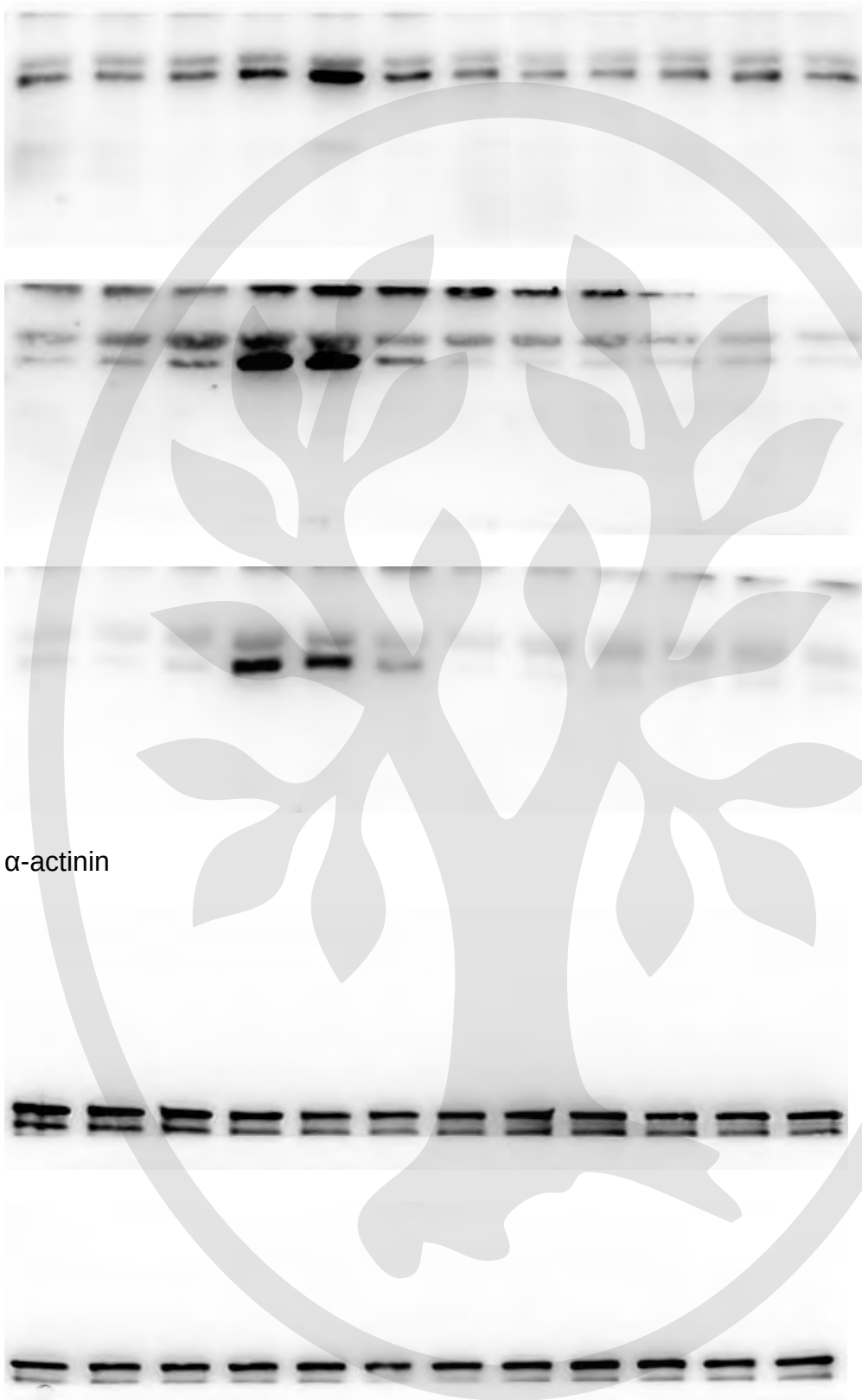


MEK1/2 S217/221

Total MEK1/2







$\alpha$ -actinin



Fig 3

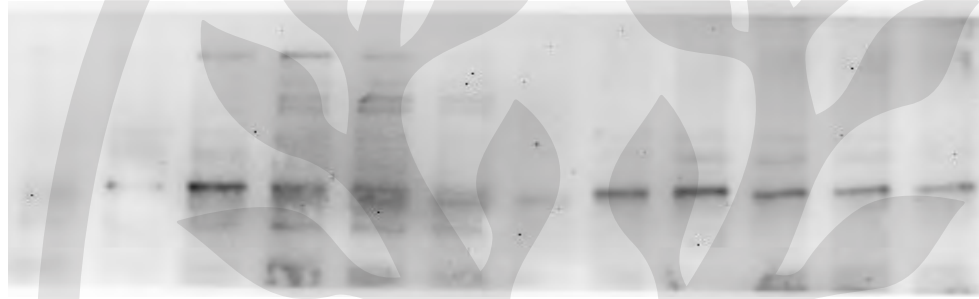
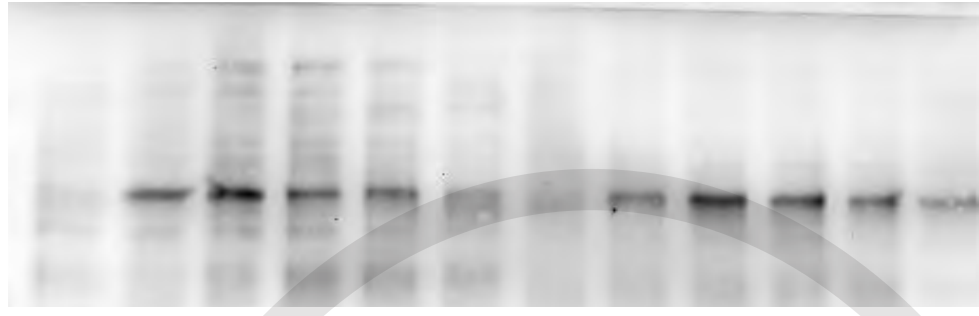
Syk S297



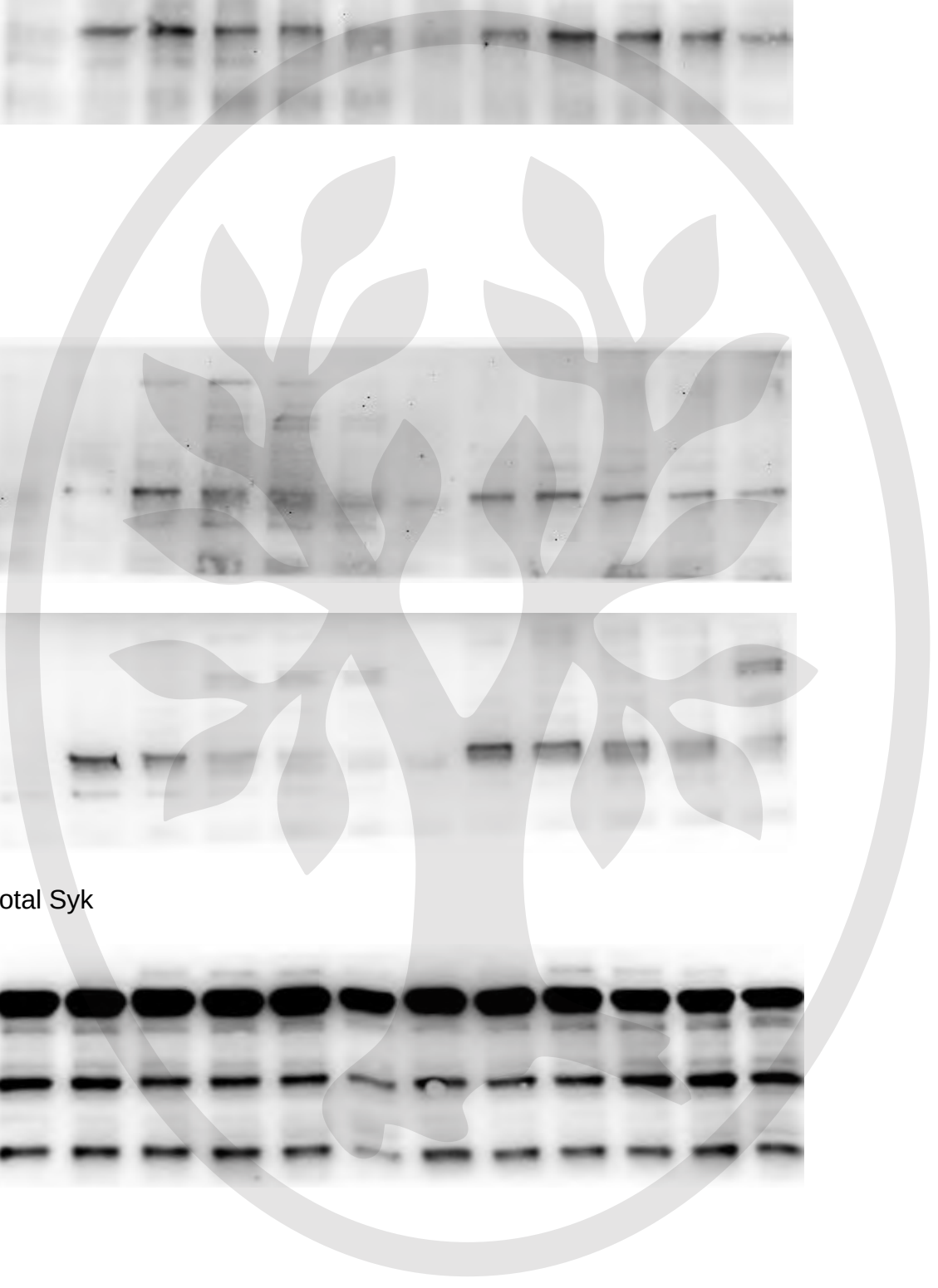
Syk Y352

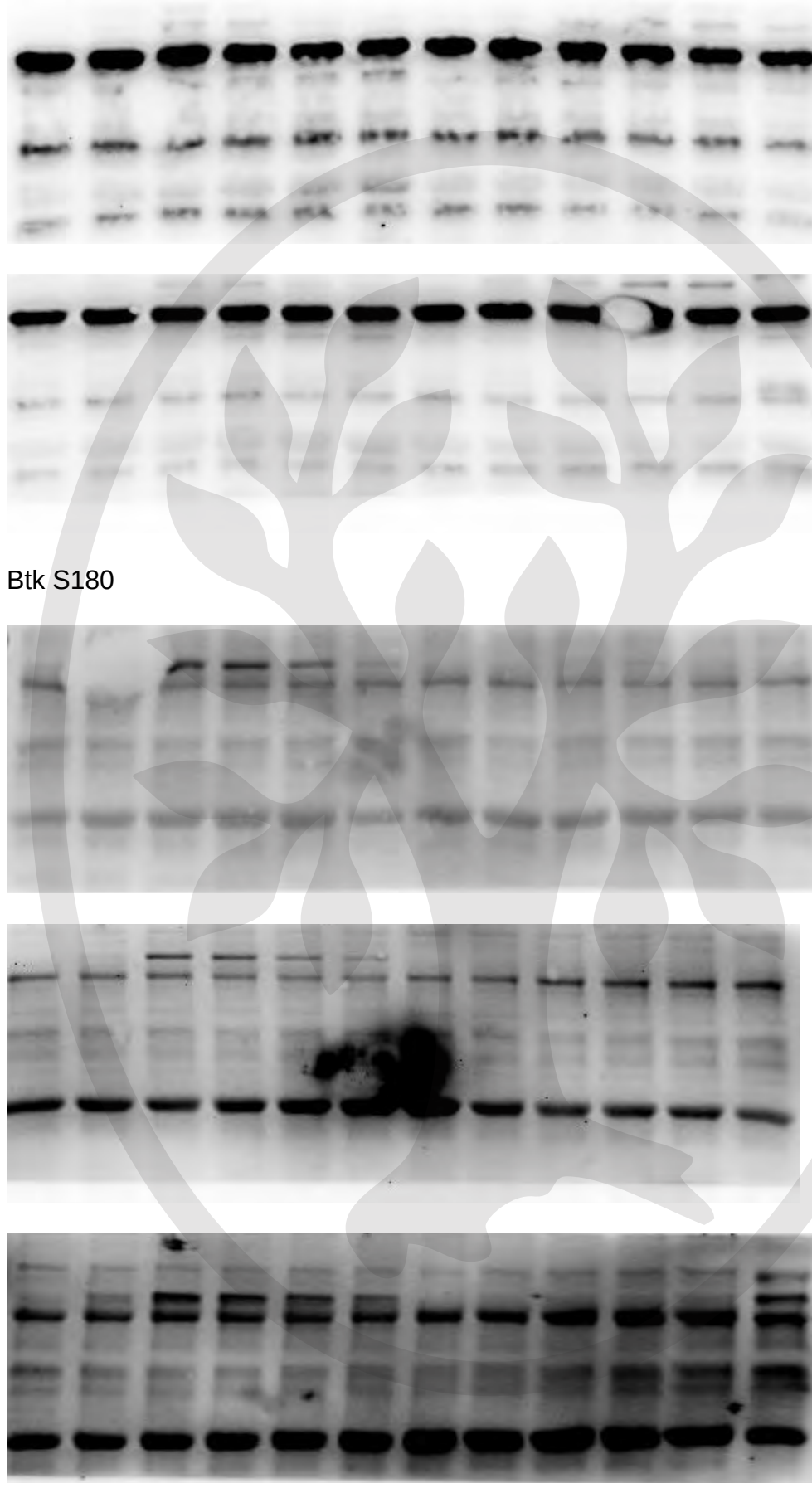


Syk Y525/526

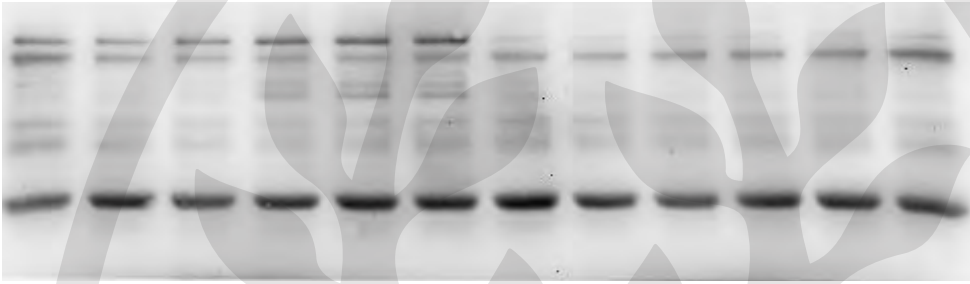


Total Syk

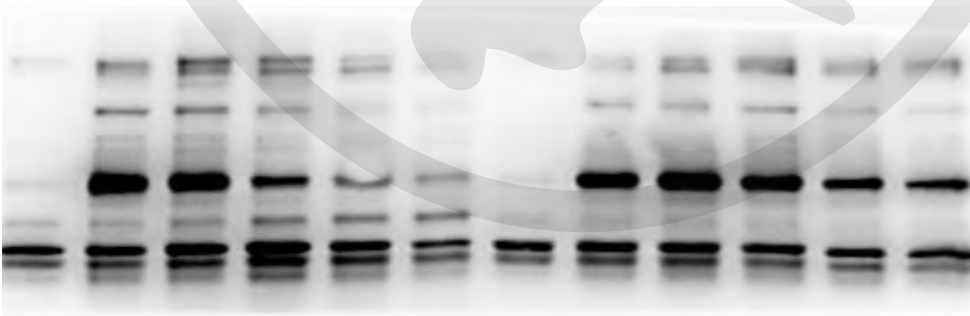
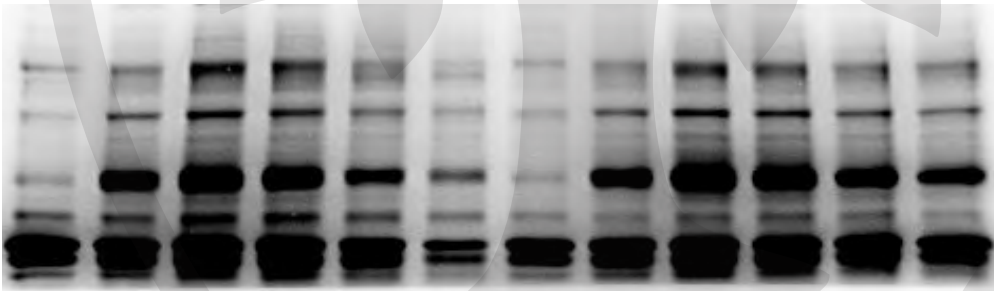




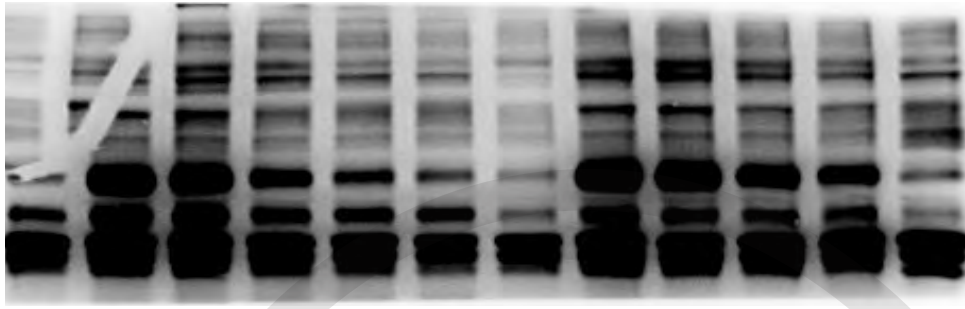
Btk Y223



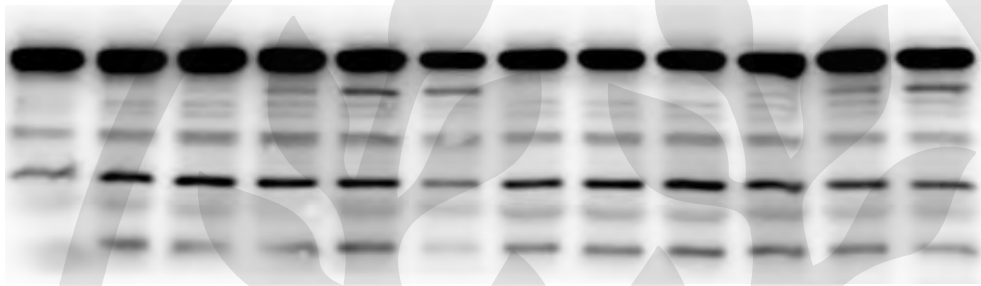
Btk Y551





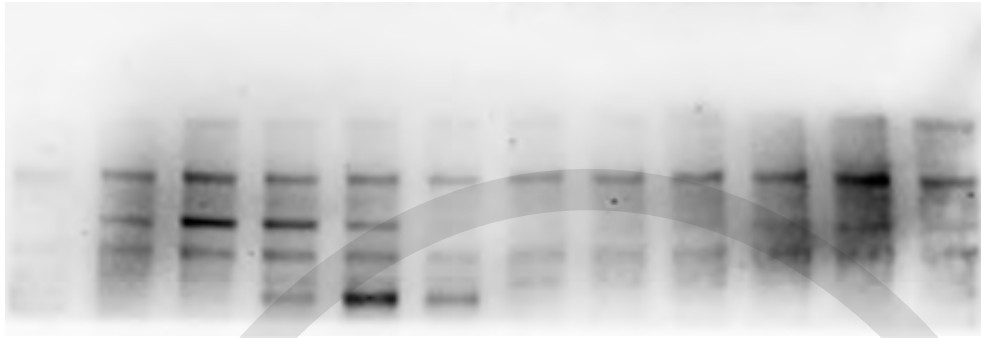


Total Btk



PLCy2 Y759

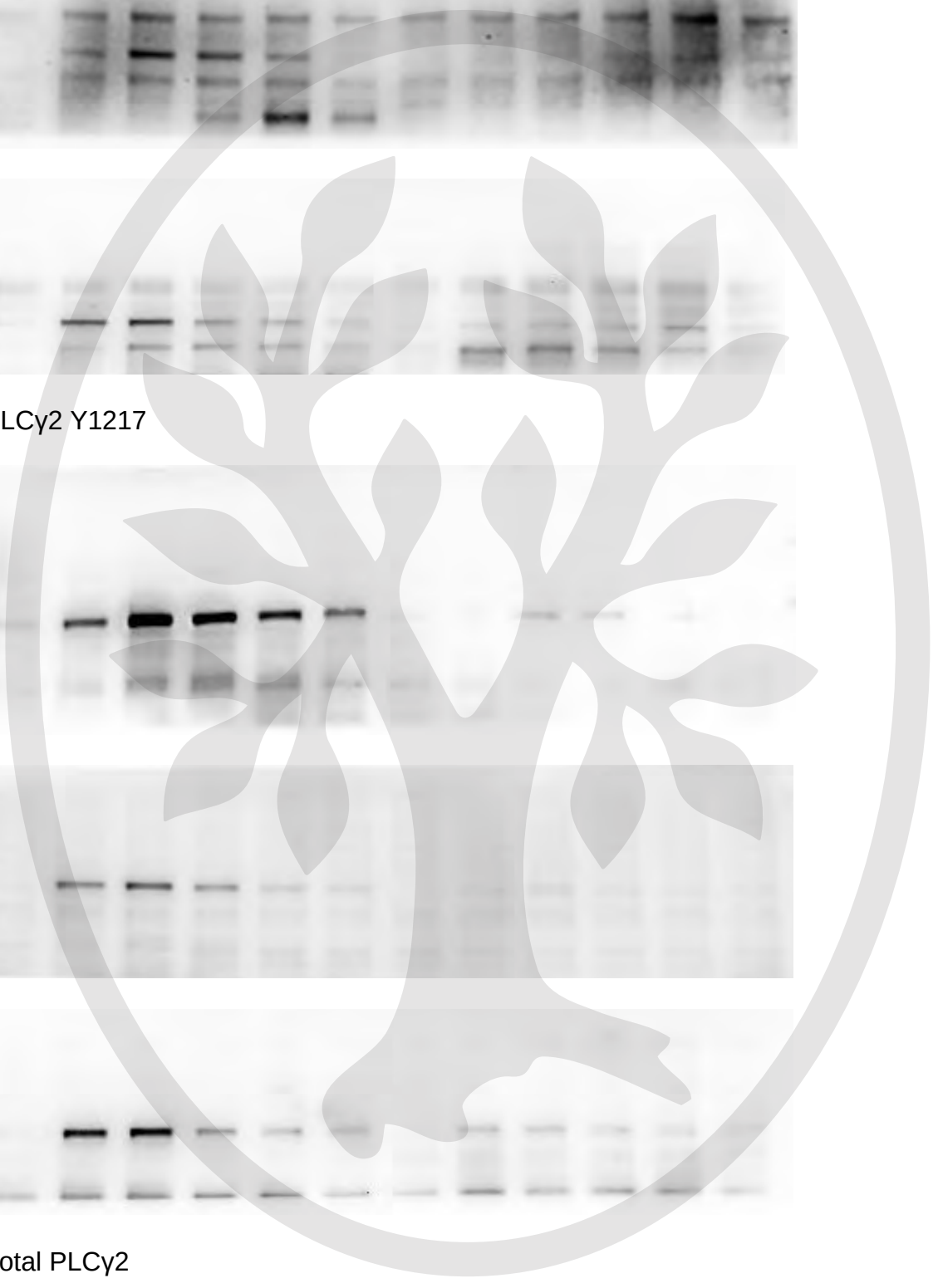


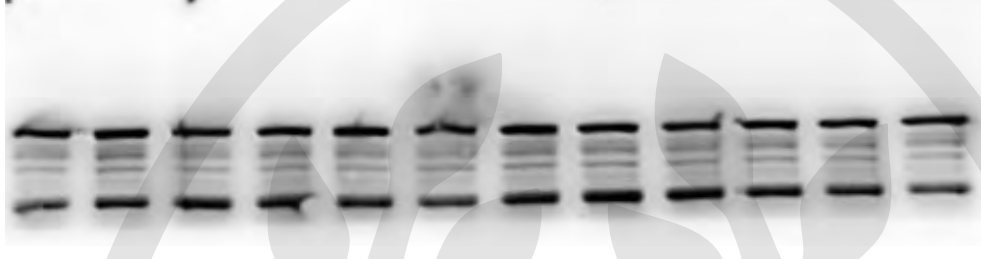
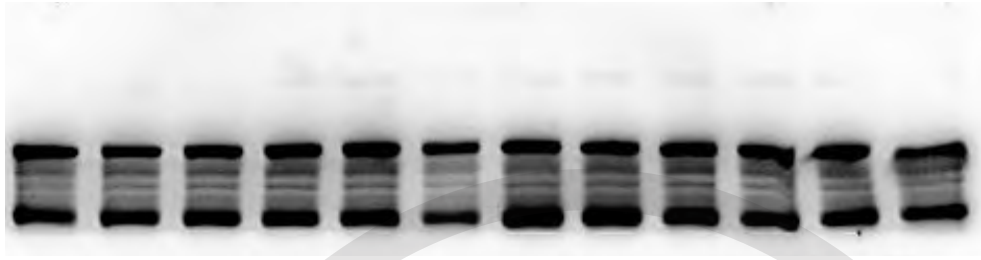


PLCy2 Y1217

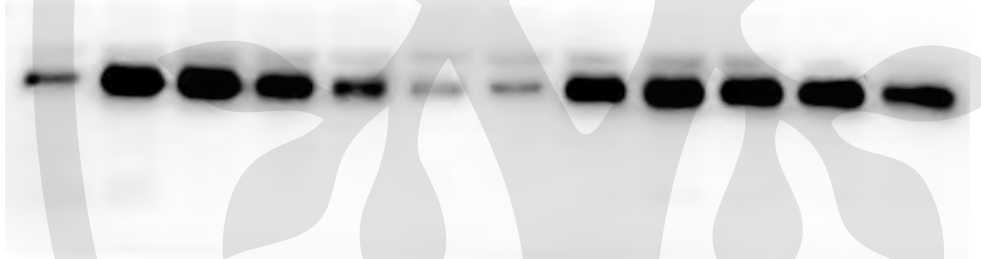


Total PLCy2

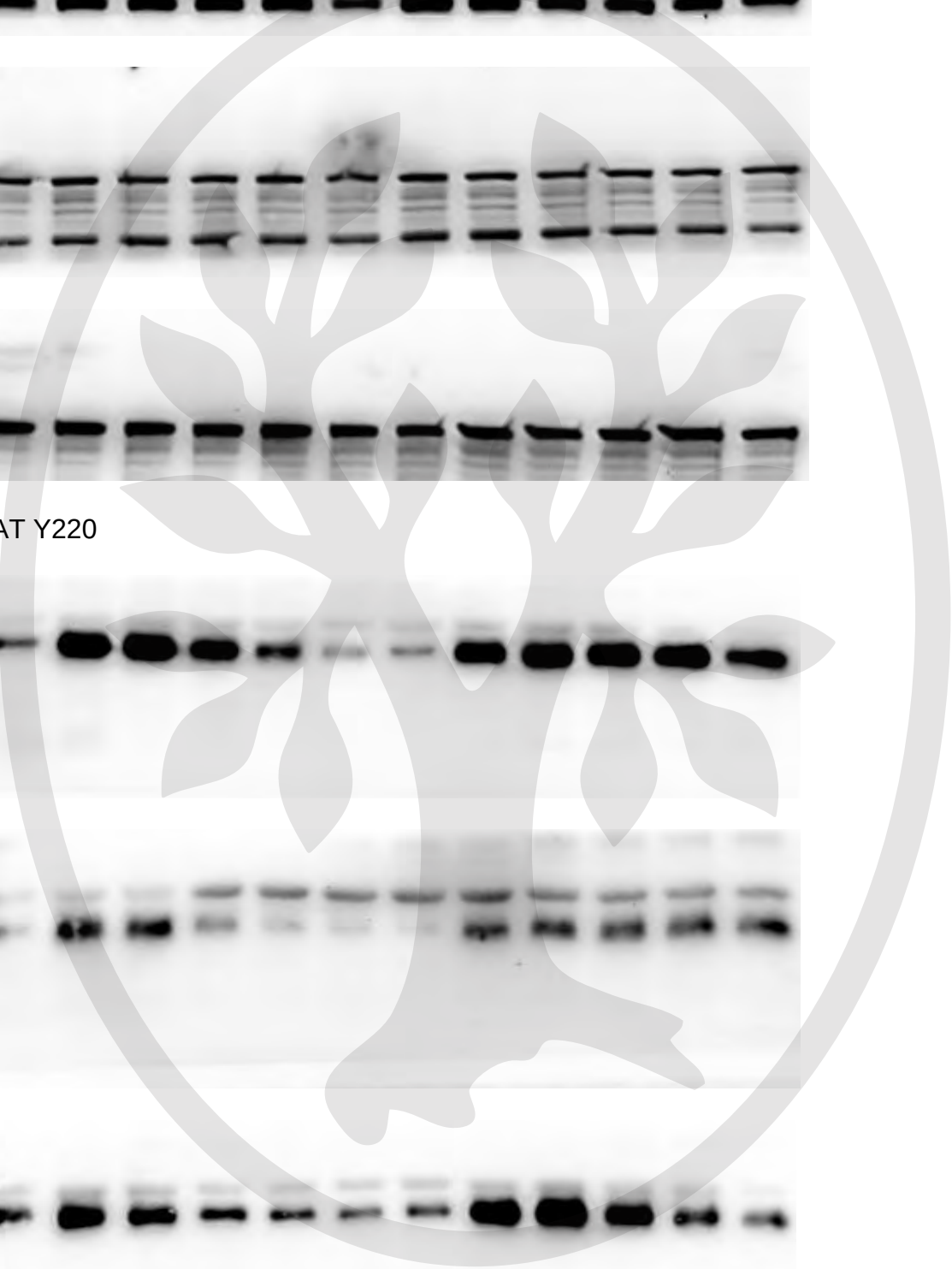


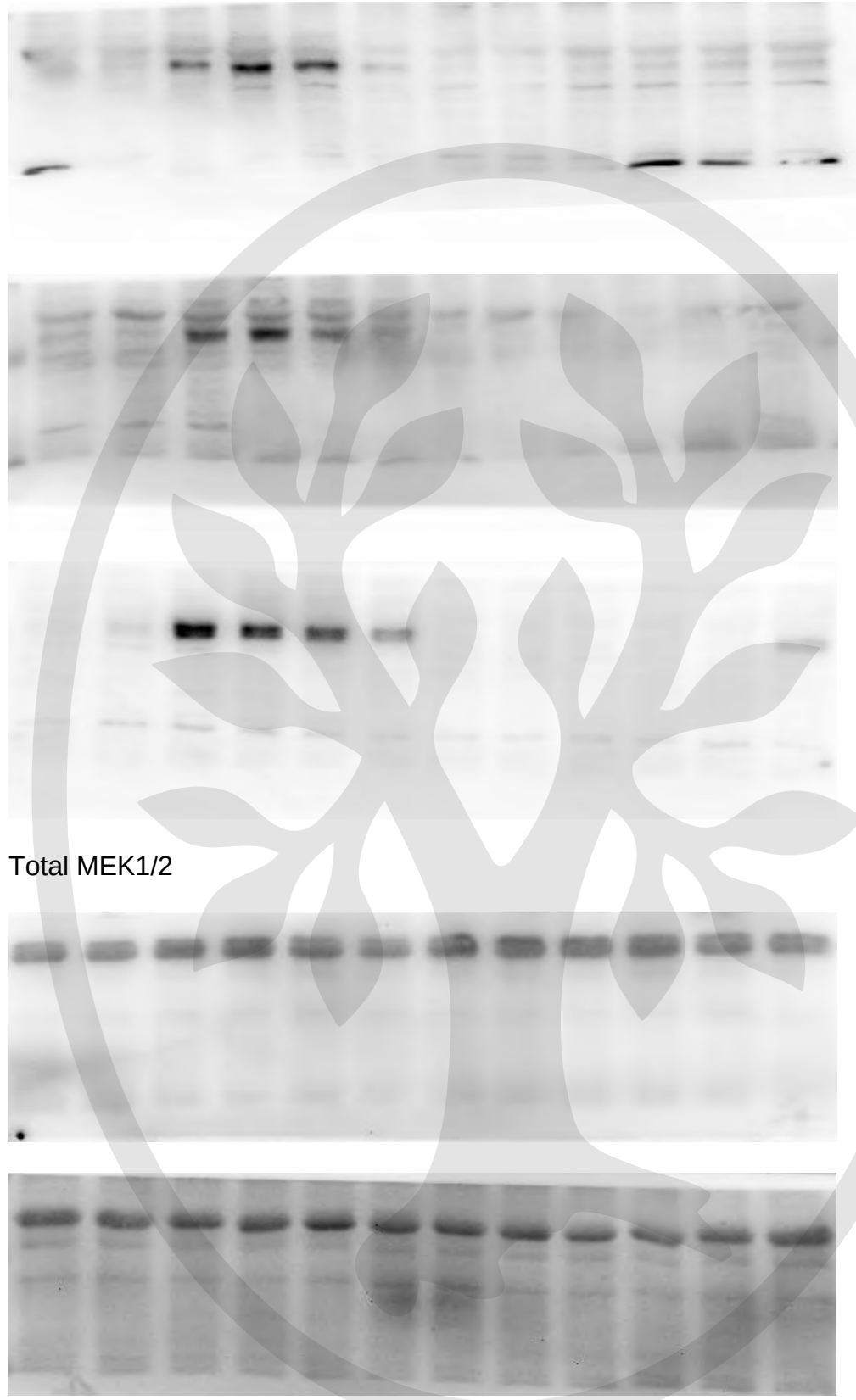


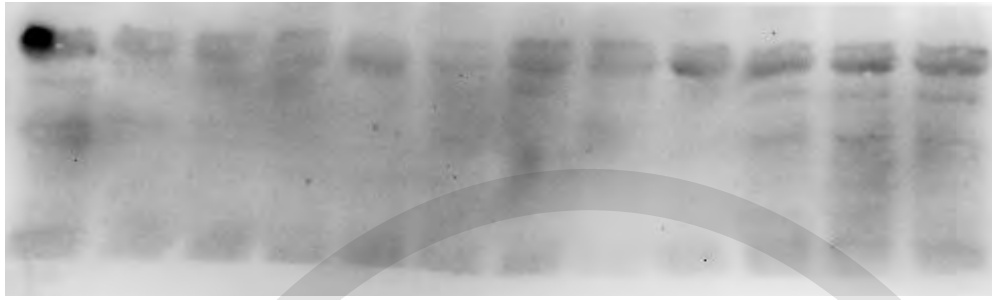
LAT Y220



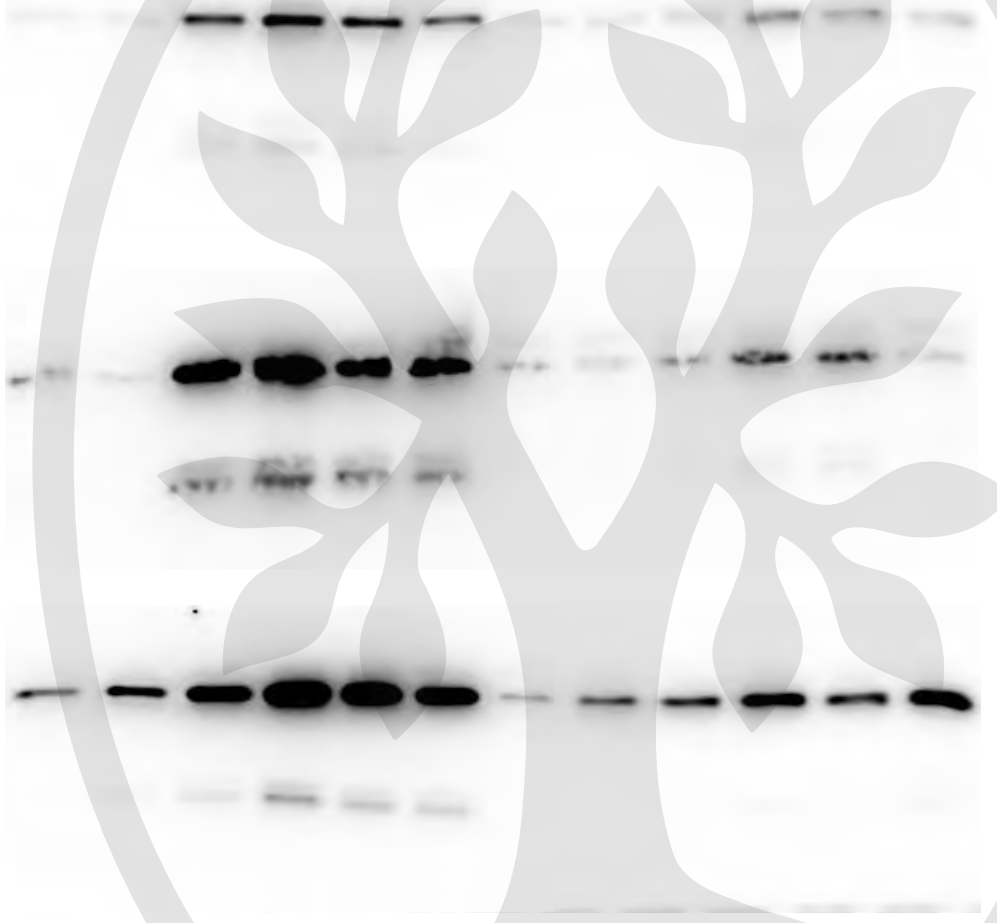
MEK1/2 S217/221







P38



Erk T202/Y204



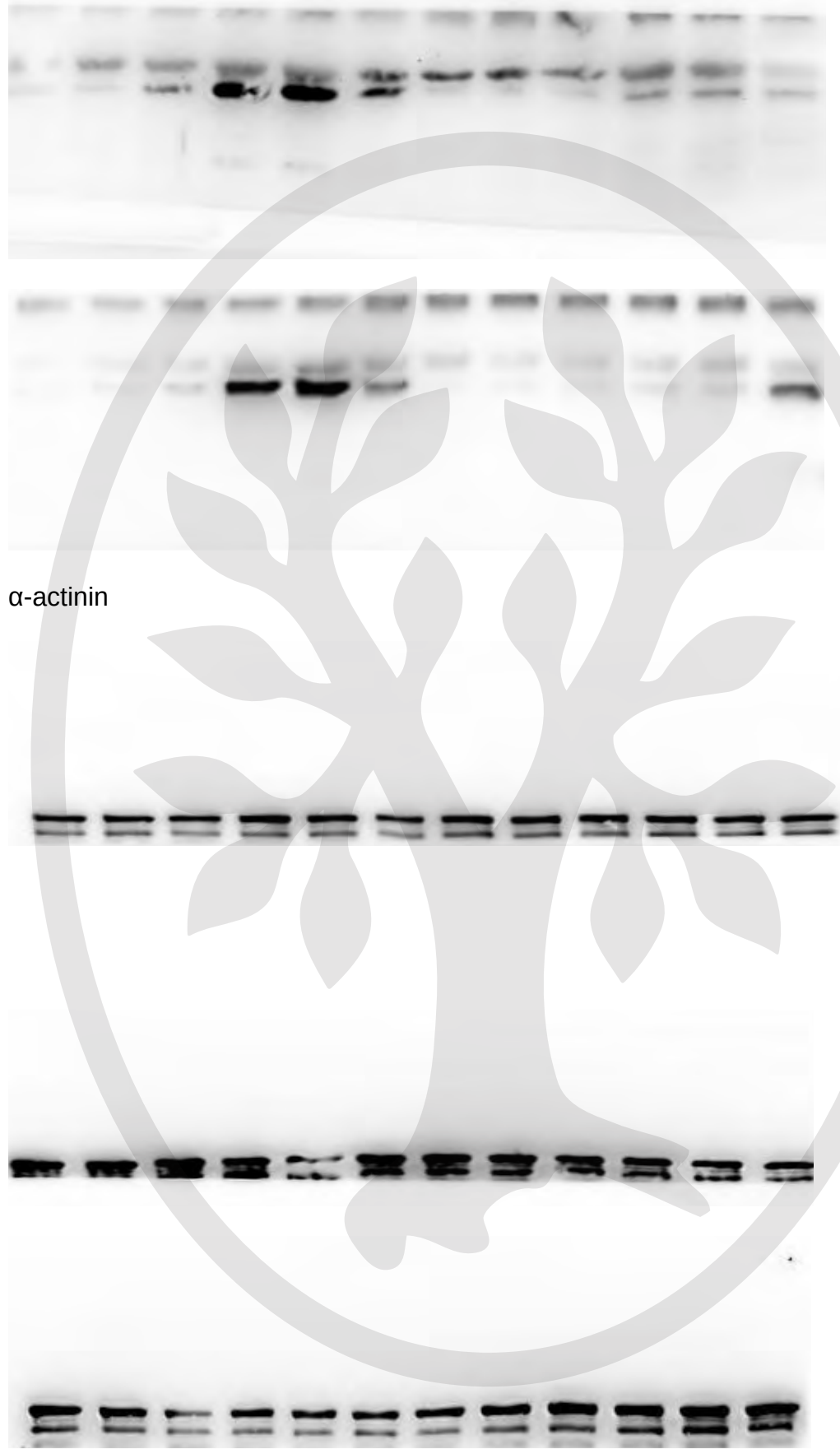
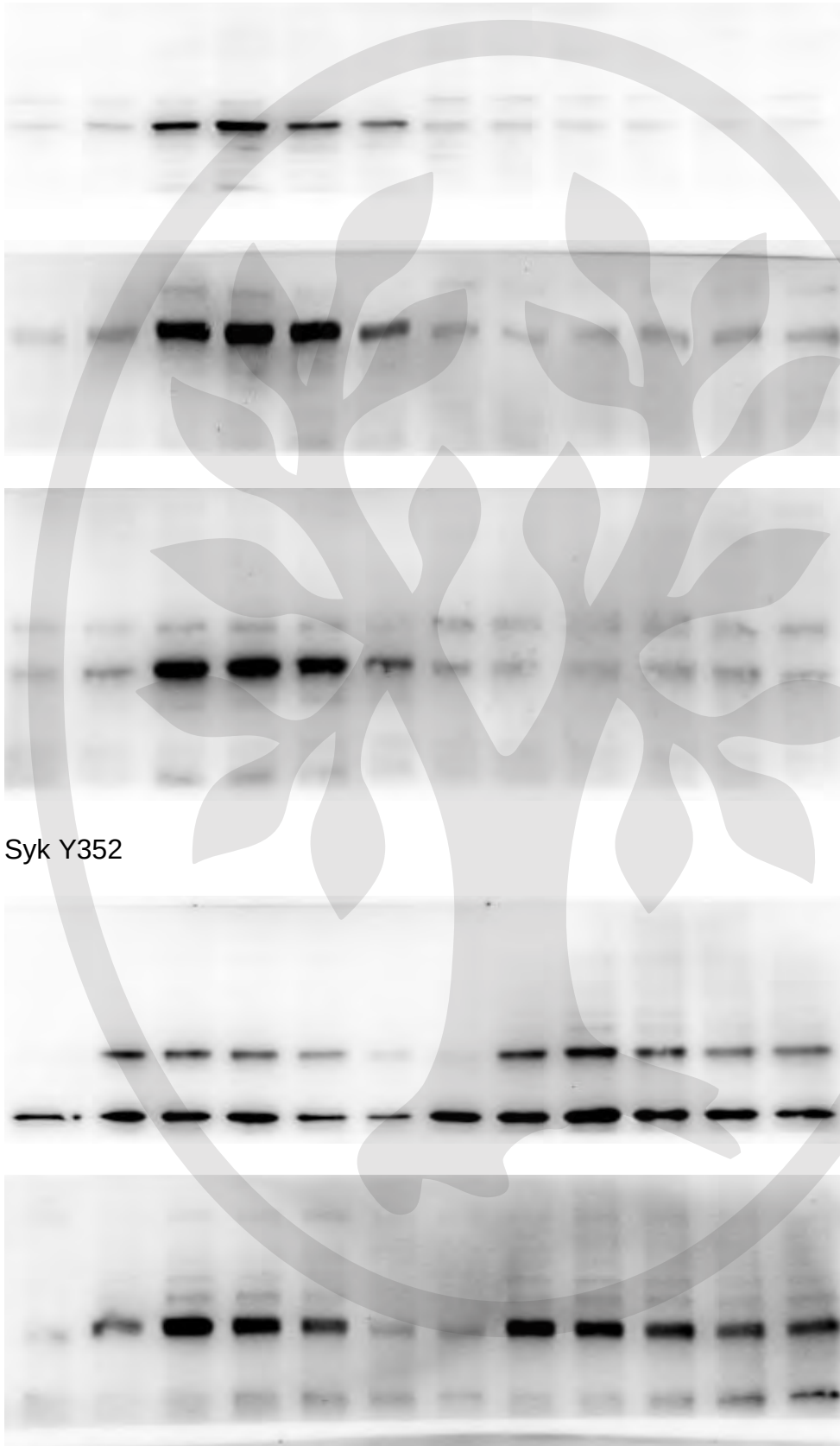


Fig 4

Syk S297



Syk Y352





Syk Y525/526

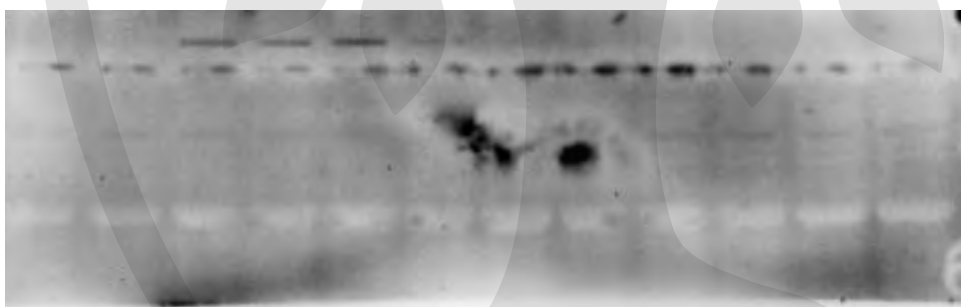
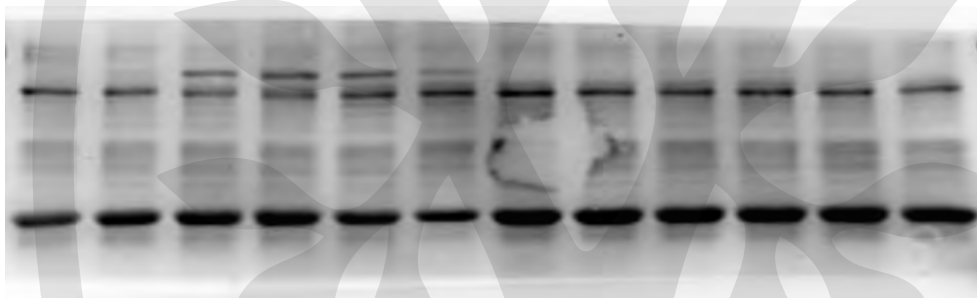


Total Syk

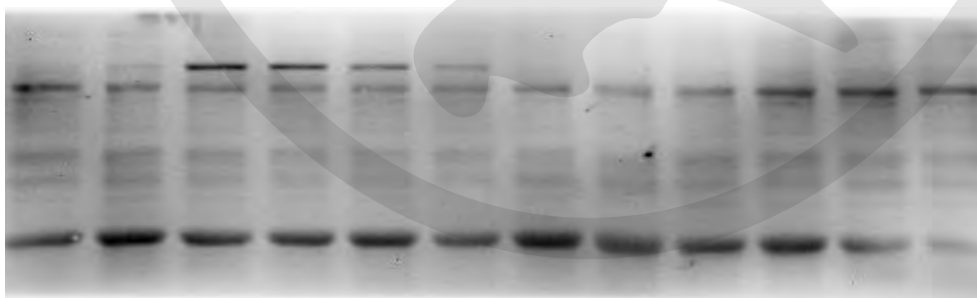


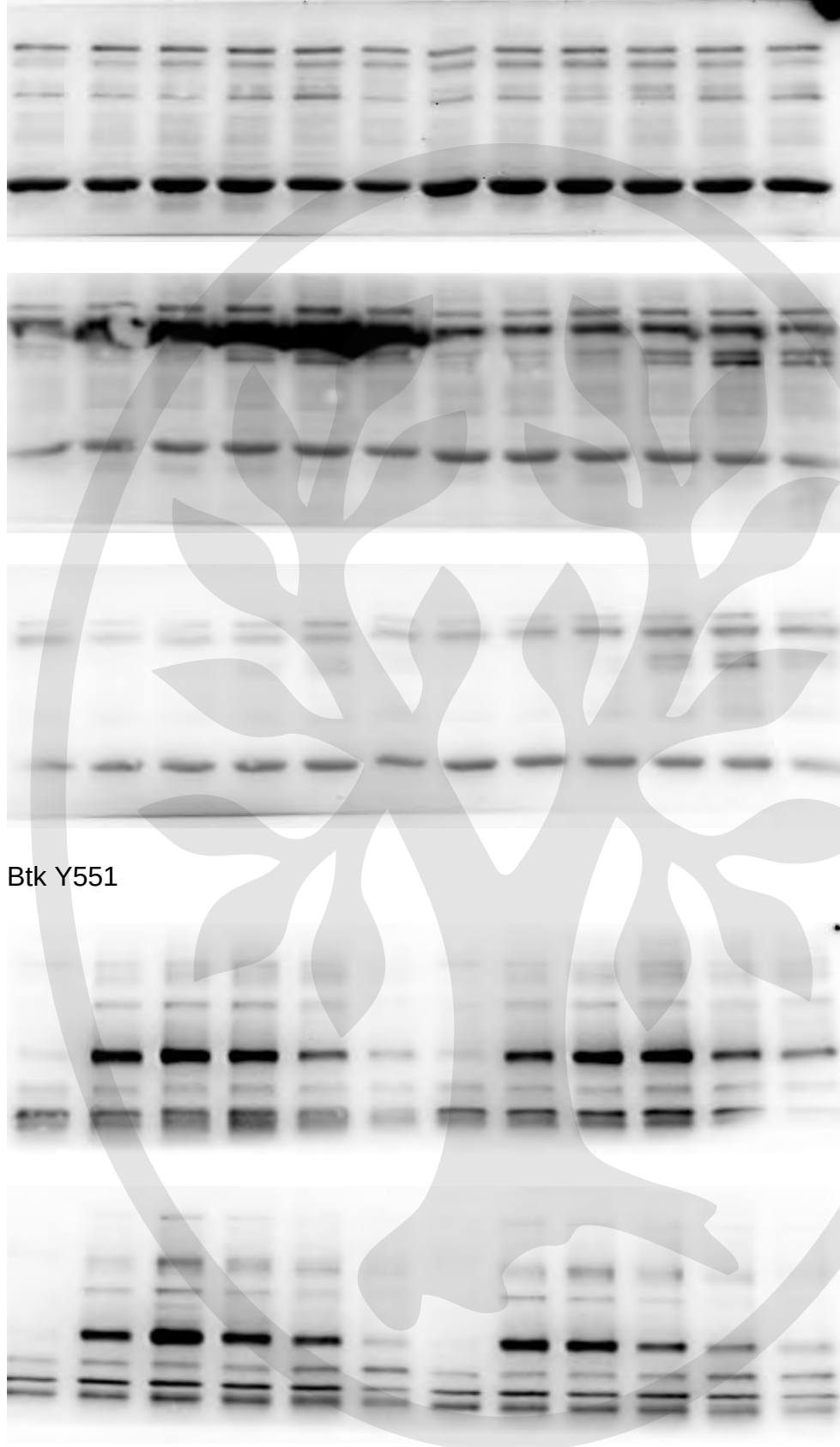


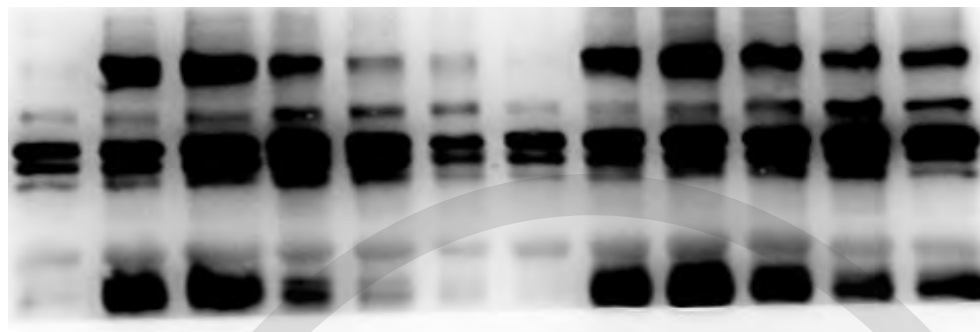
Btk S180



Btk Y223







Total Btk



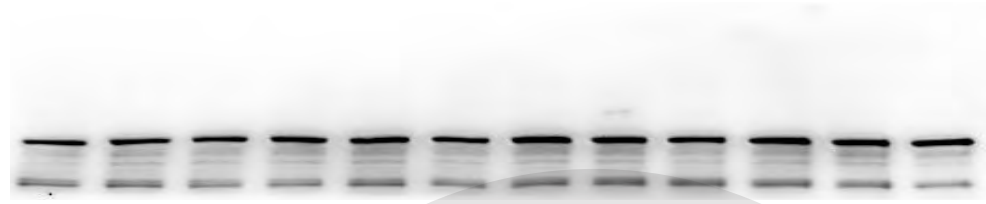
PLCy2 Y759



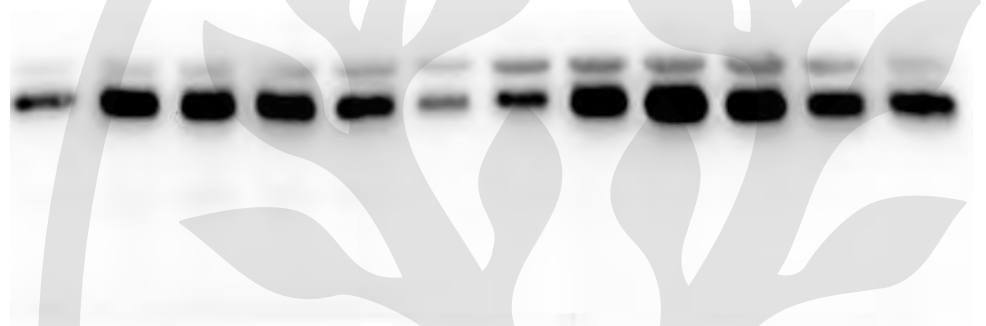


PLCy2 Y1217

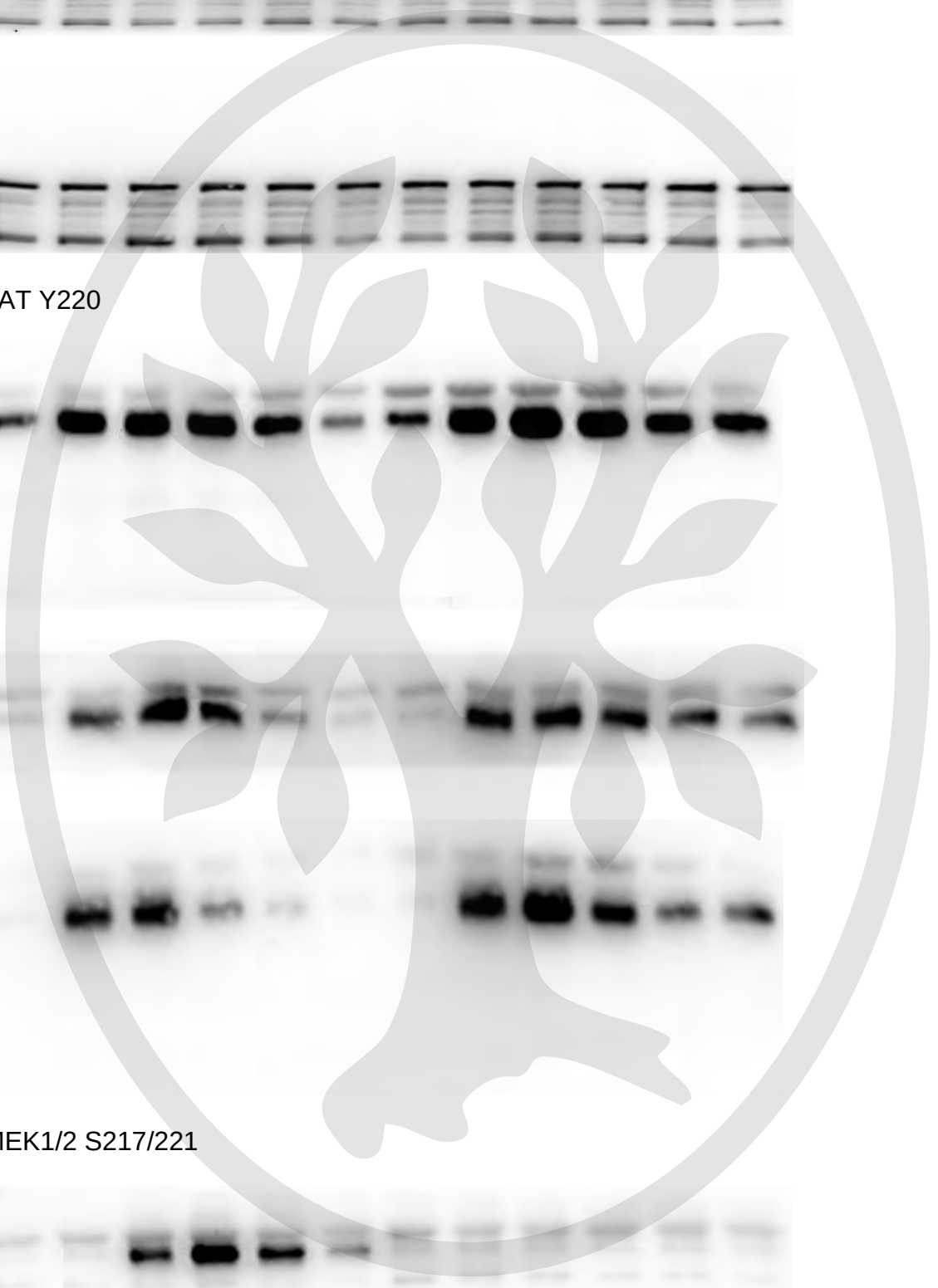
Total PLCy2



LAT Y220



MEK1/2 S217/221

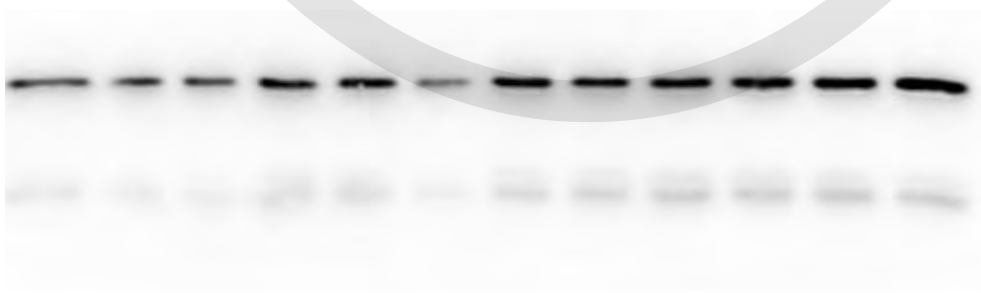




Total MEK1/2



P38

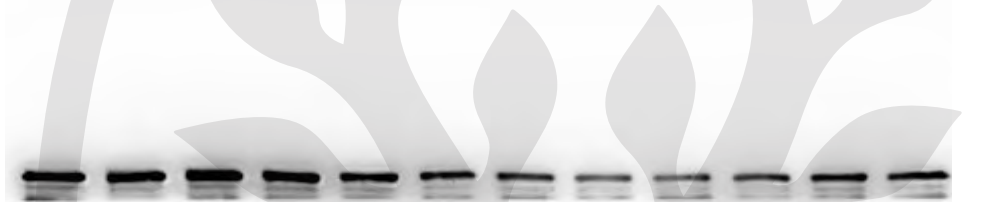






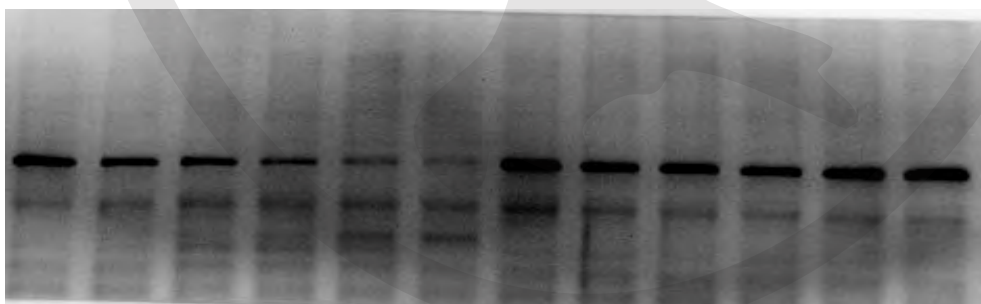
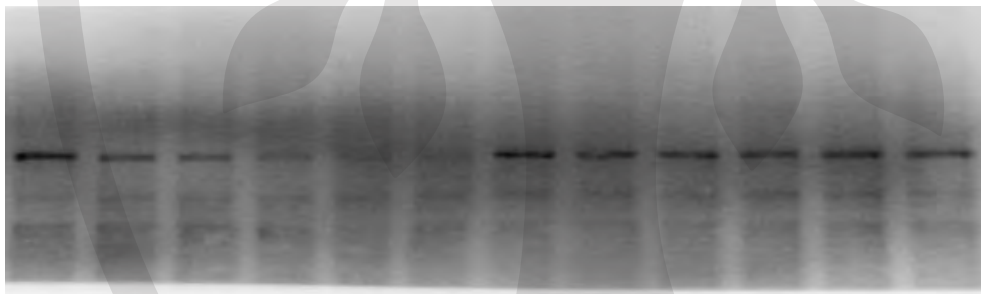
Erk T202/Y204

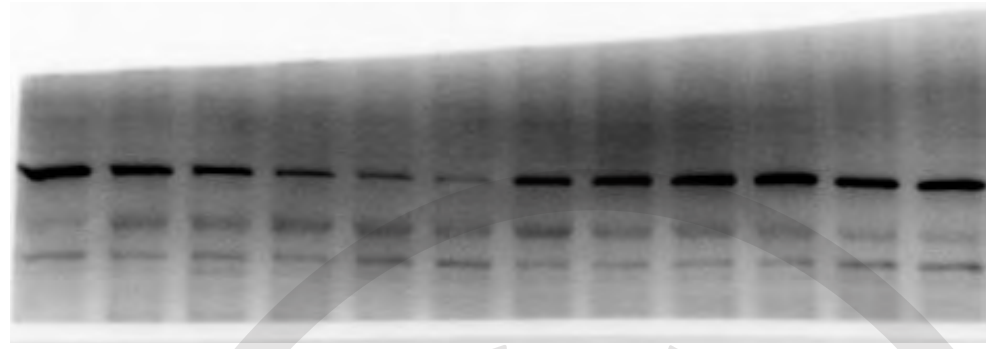
$\alpha$ -actinin



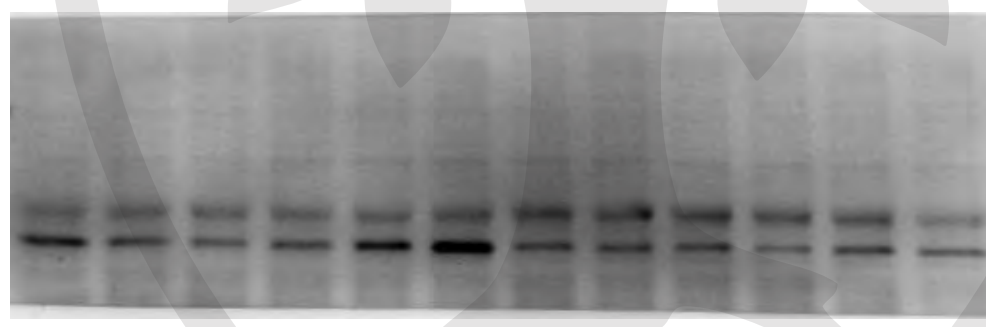
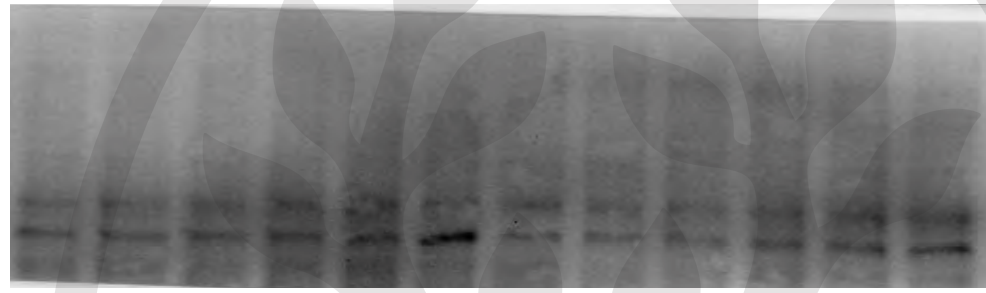
Supplementary Fig 1

Akt T308

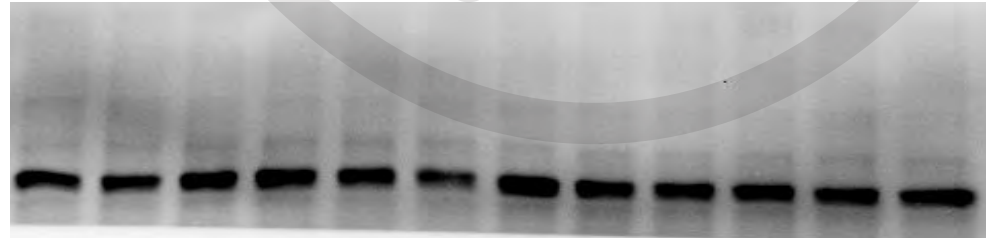


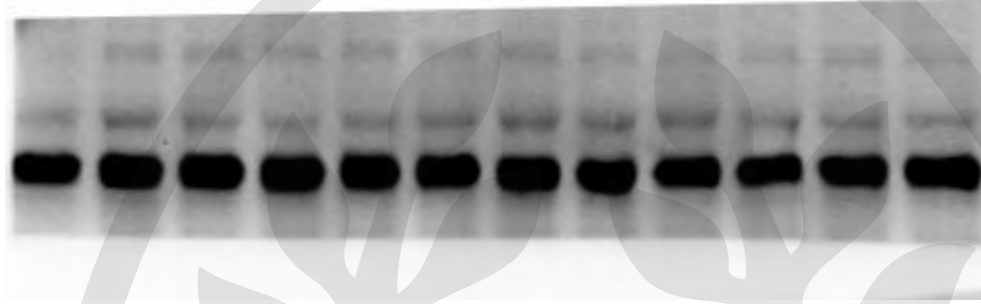
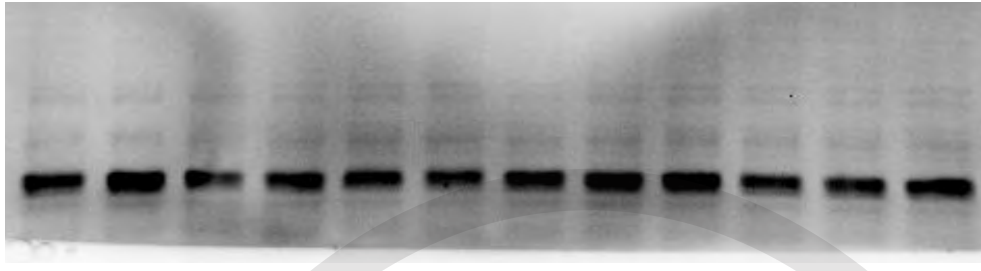


Akt S473

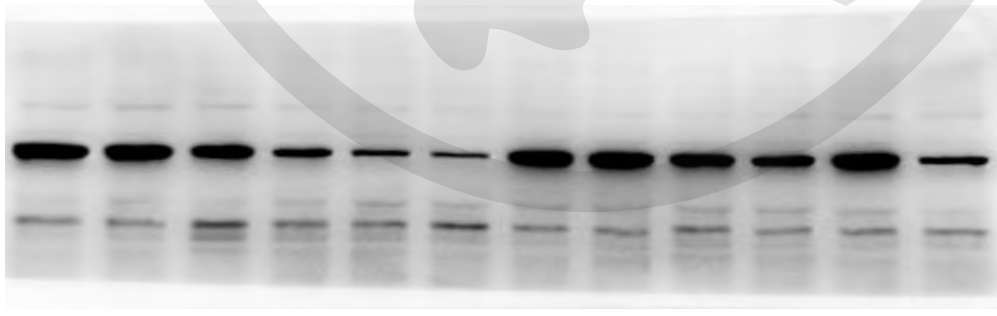
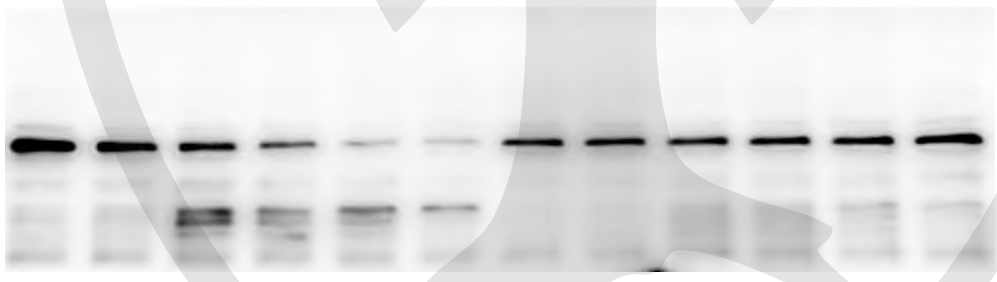
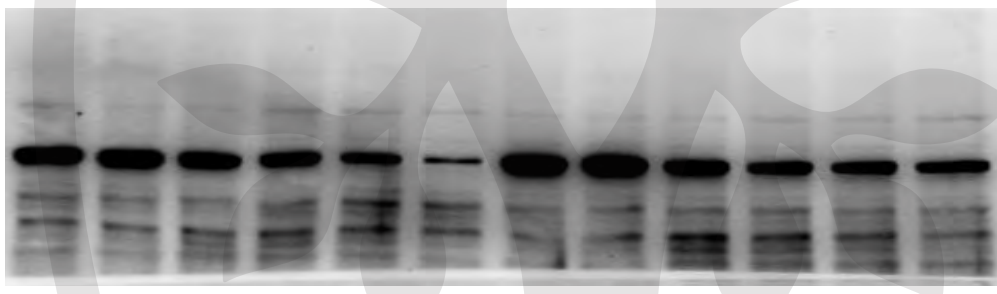


Total Akt

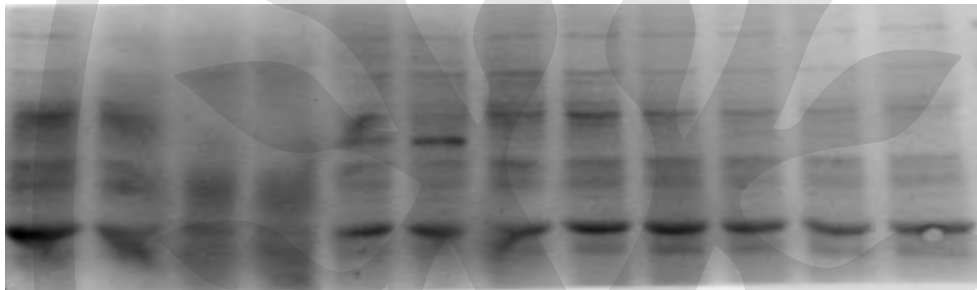
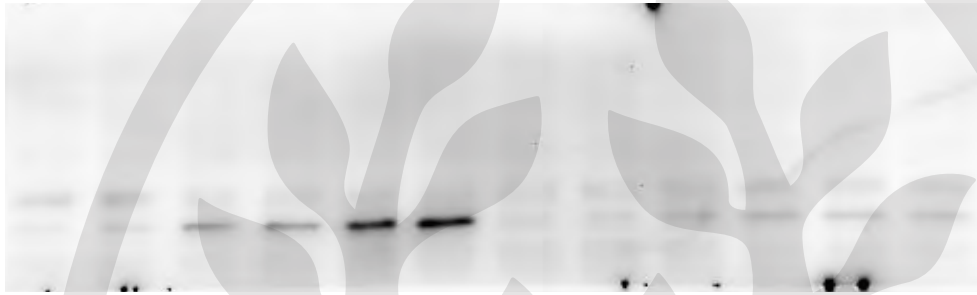
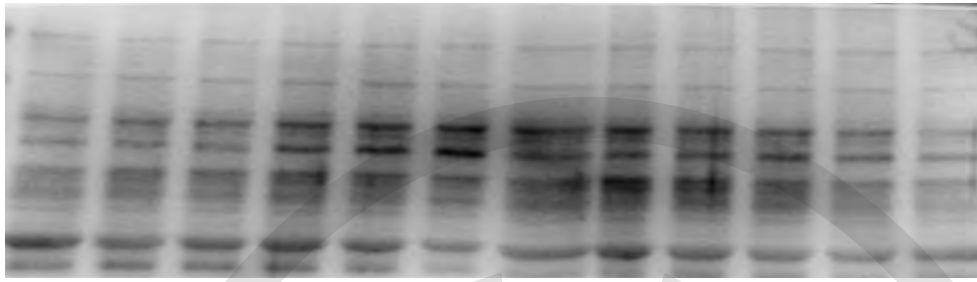




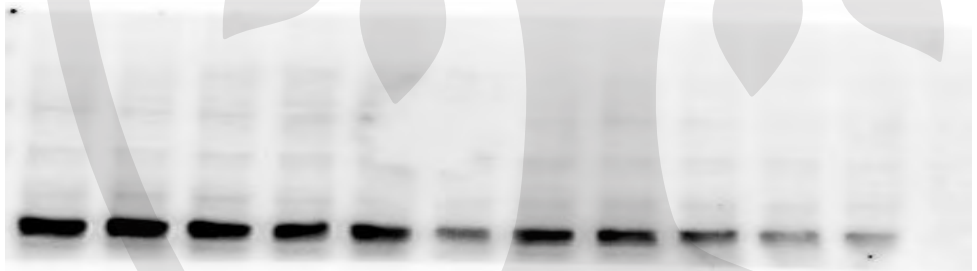
Supplementary Fig 2  
Akt T308

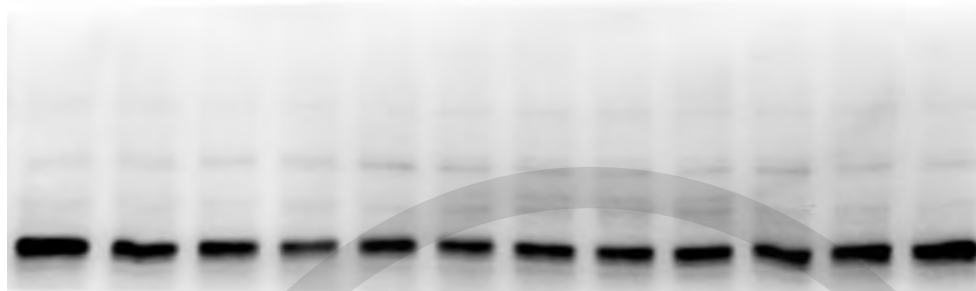


Akt S473



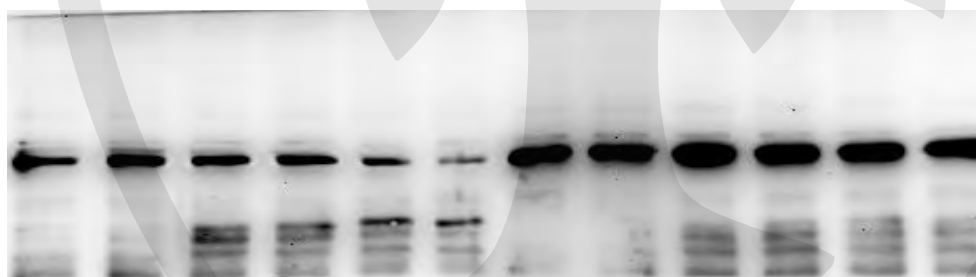
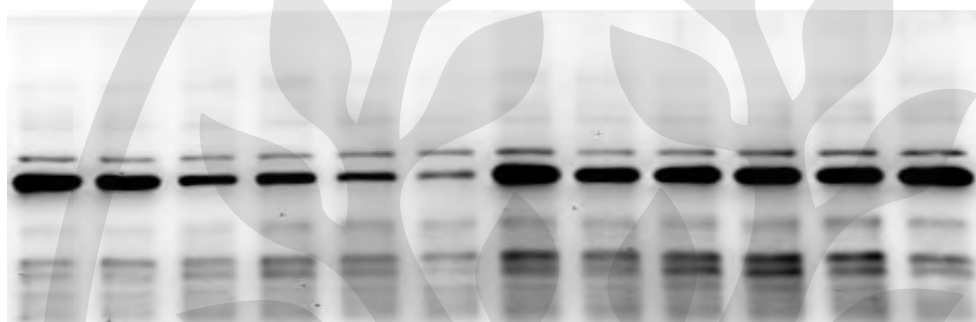
Total Akt





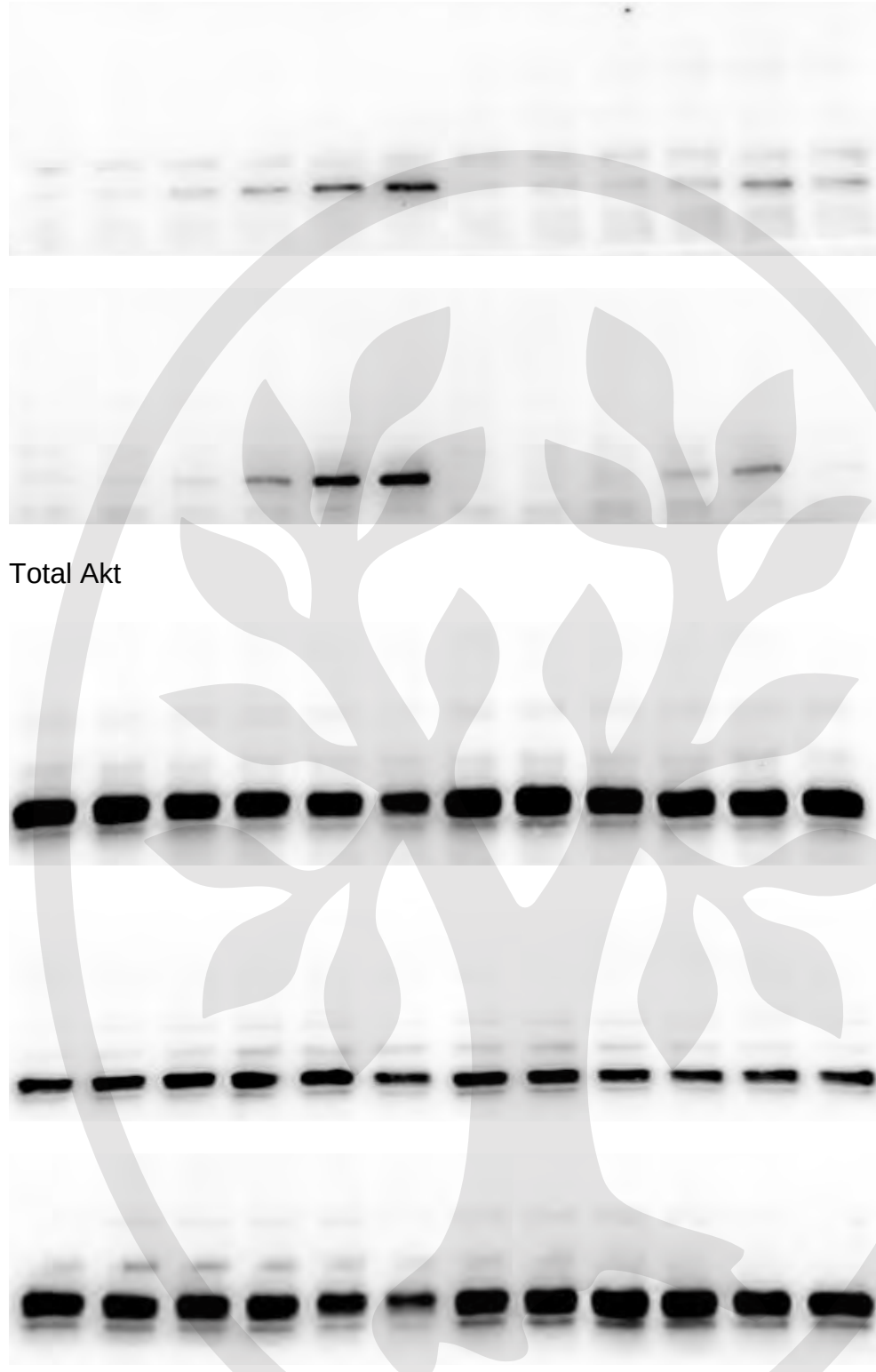
Supplementary Fig 3

Akt T308



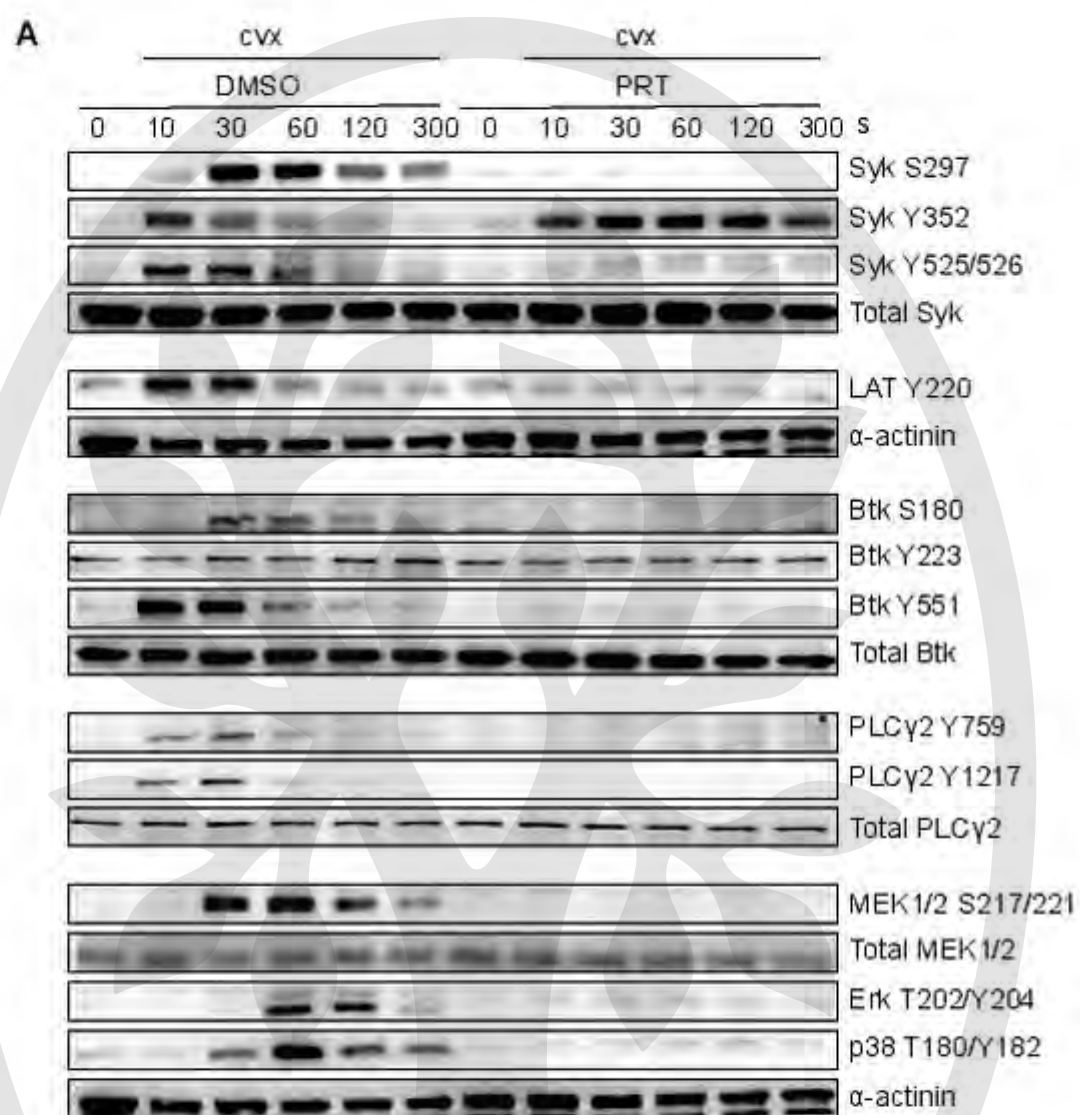
Akt S473





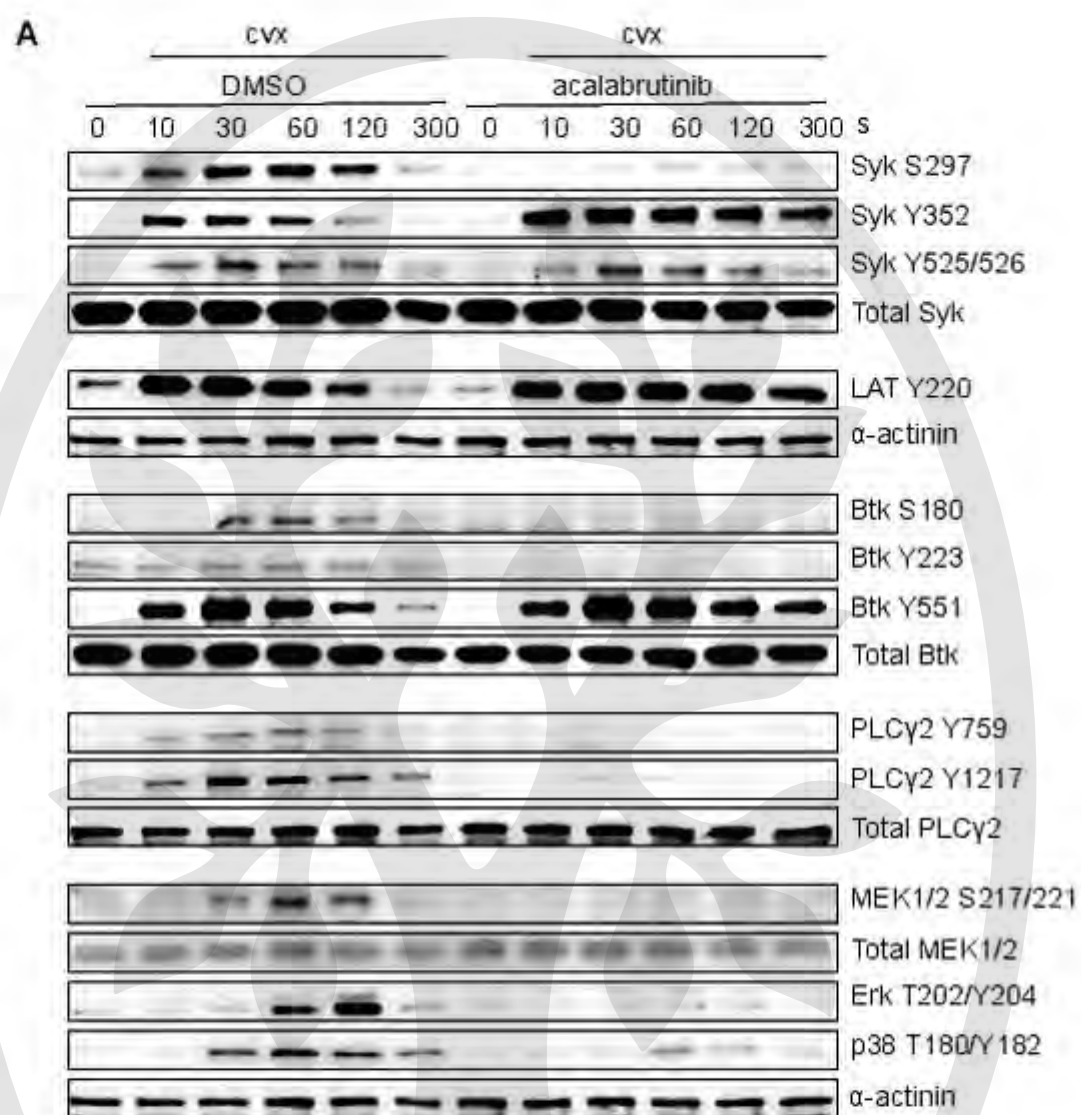






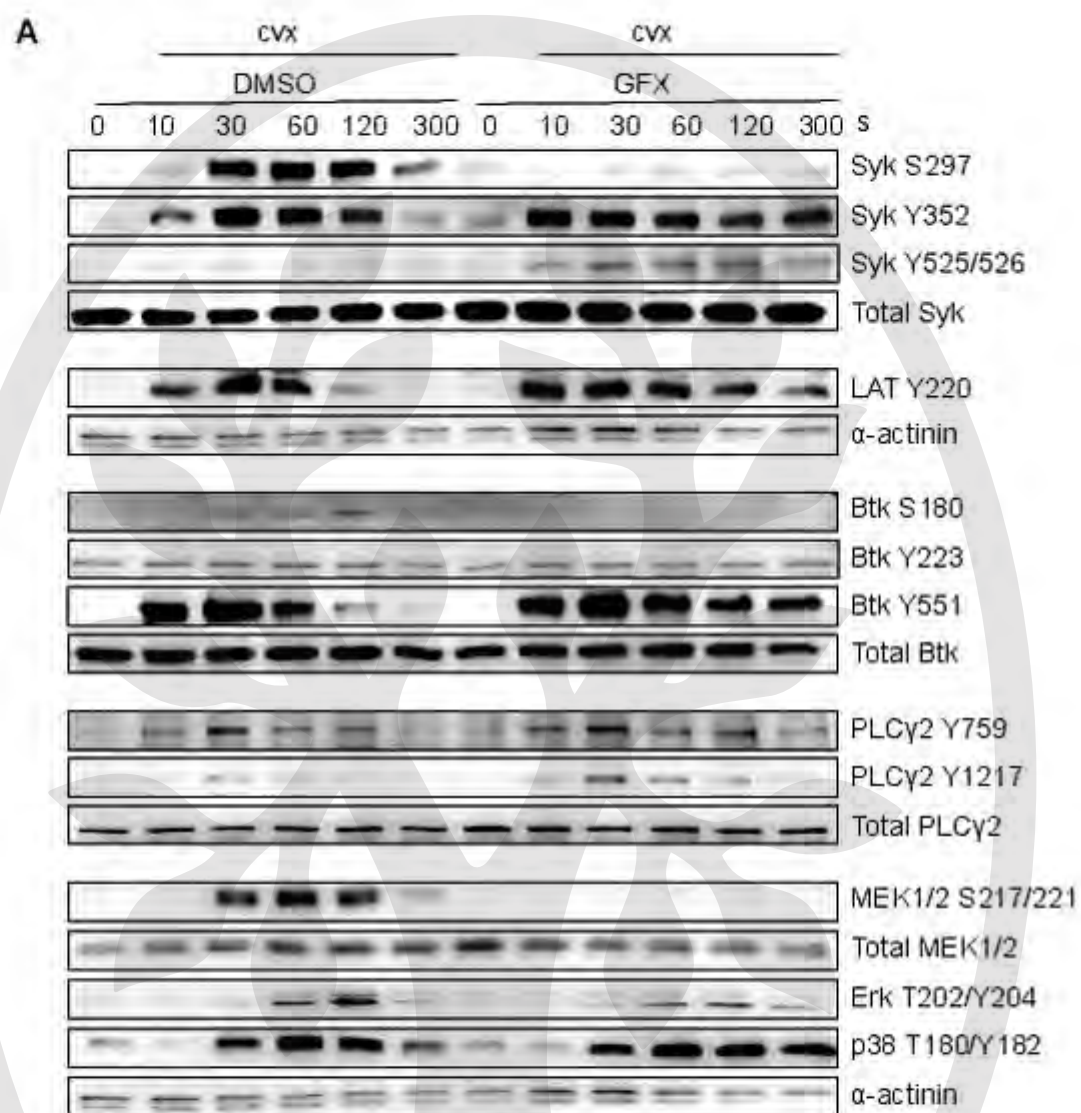
**Figure 2**





**Figure 3**

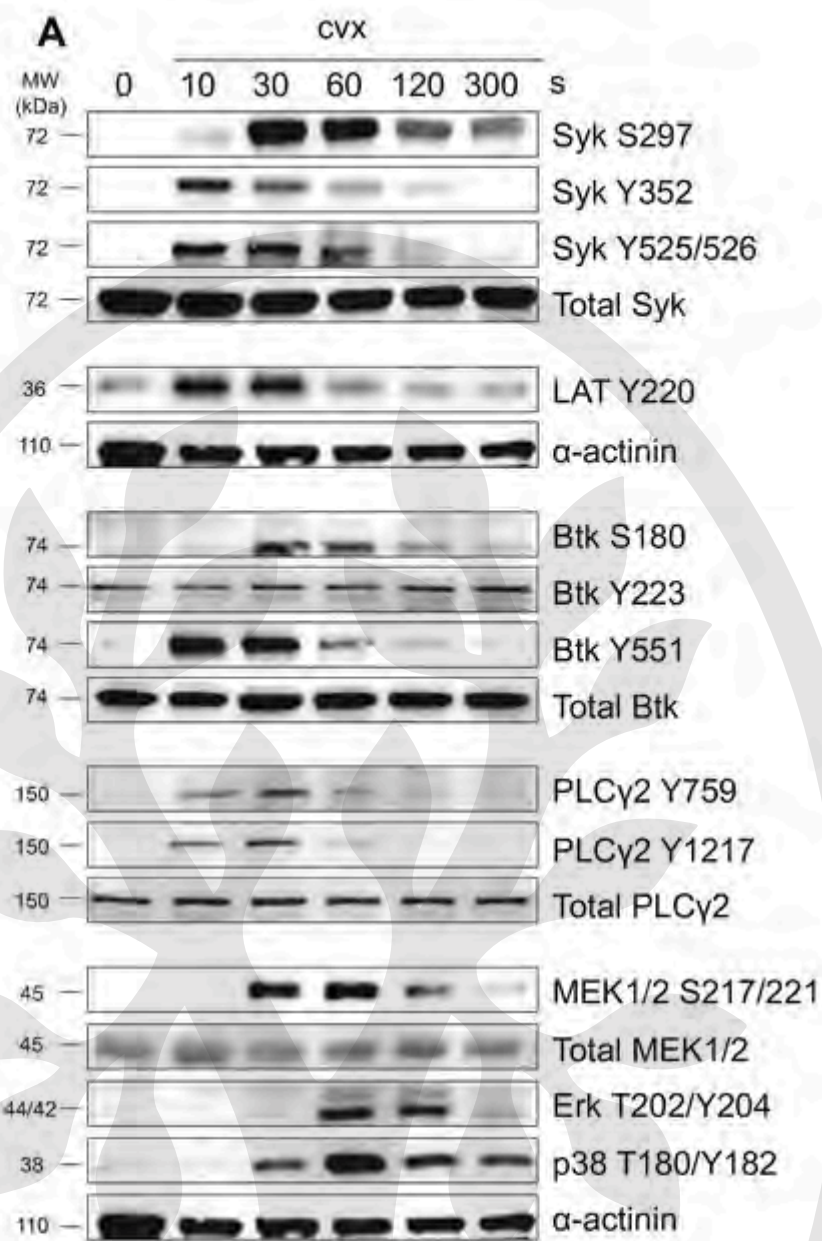




**Figure 4**







**Figure 1**



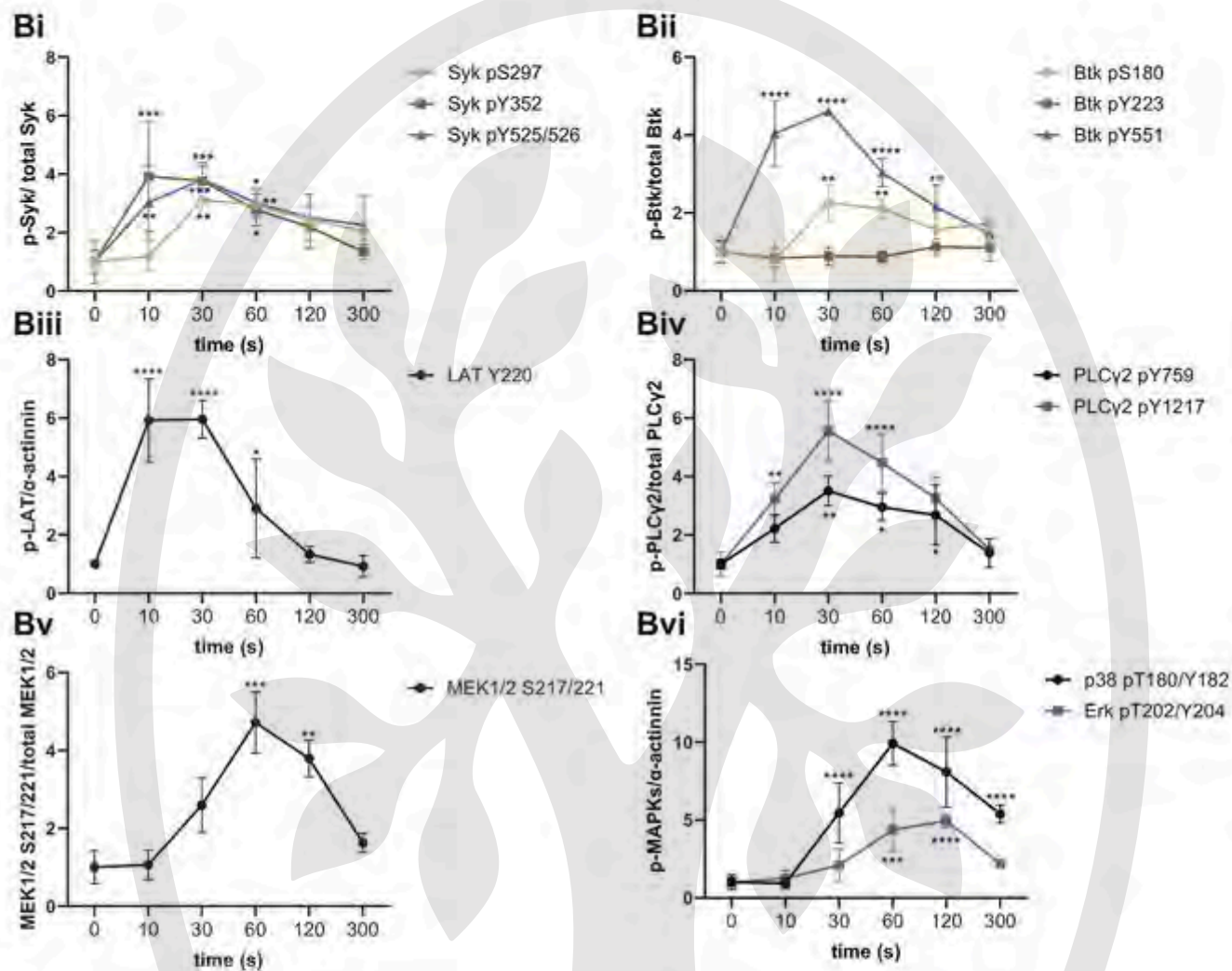
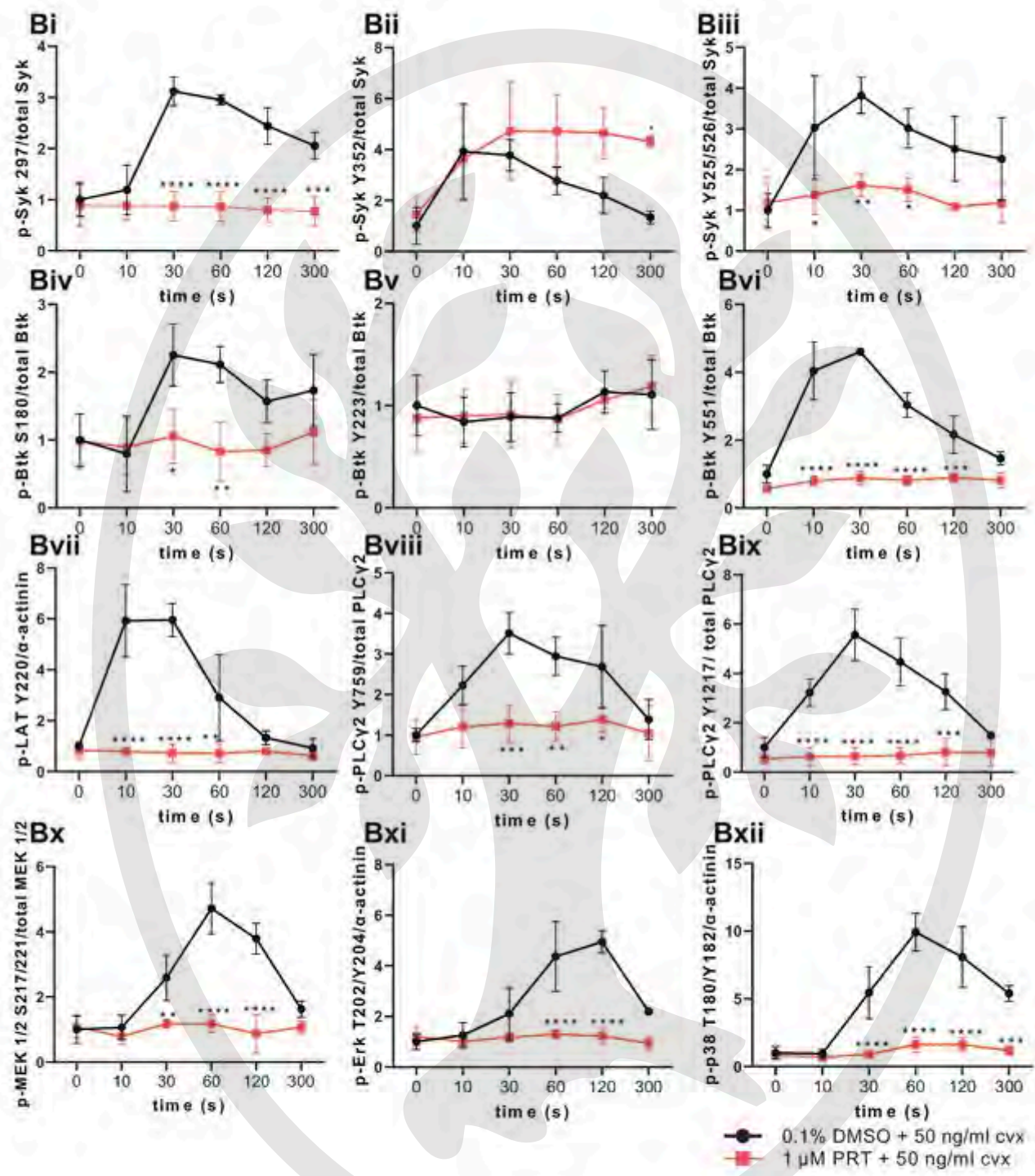


Figure 1





**Figure 2**





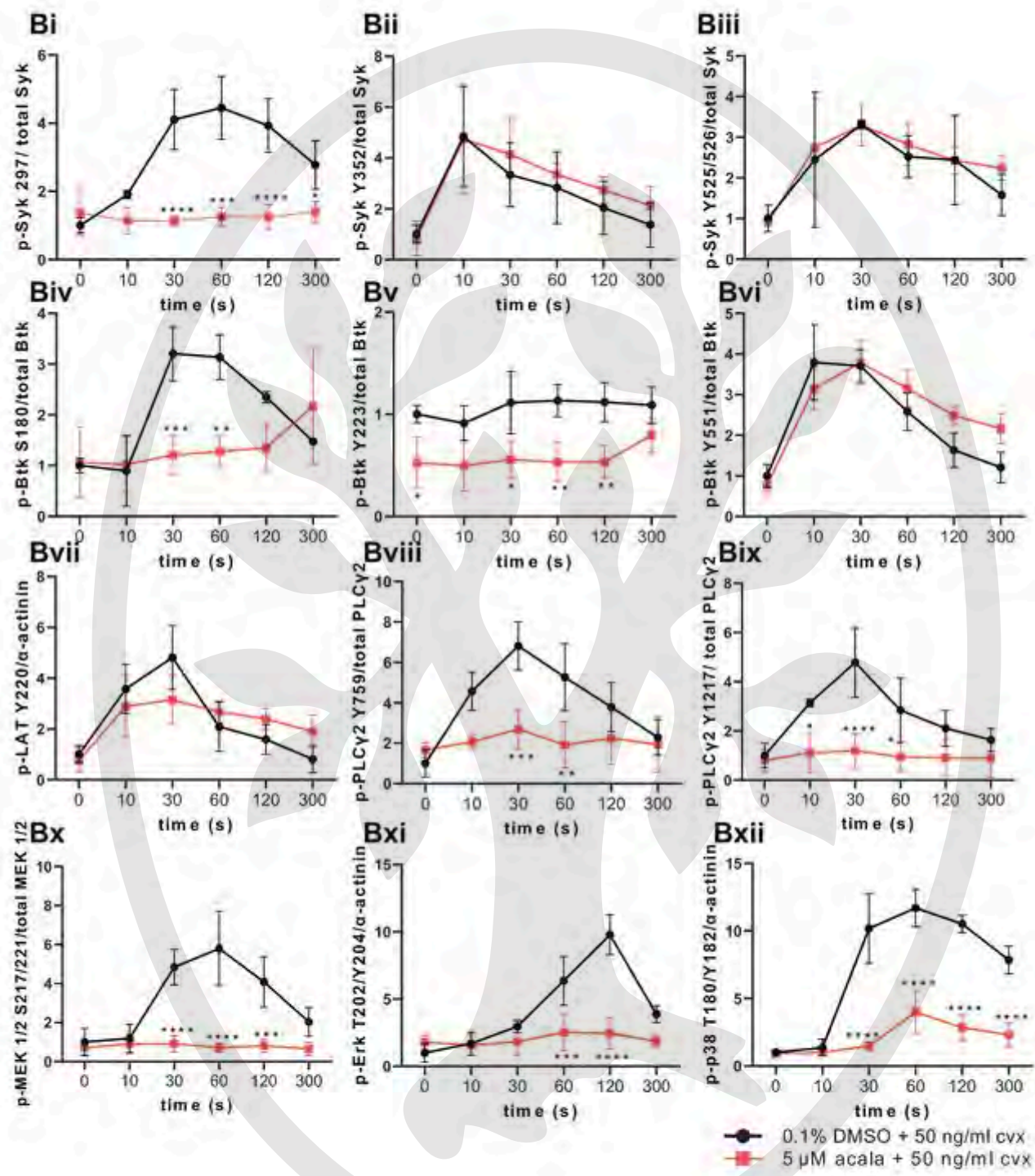


Figure 3





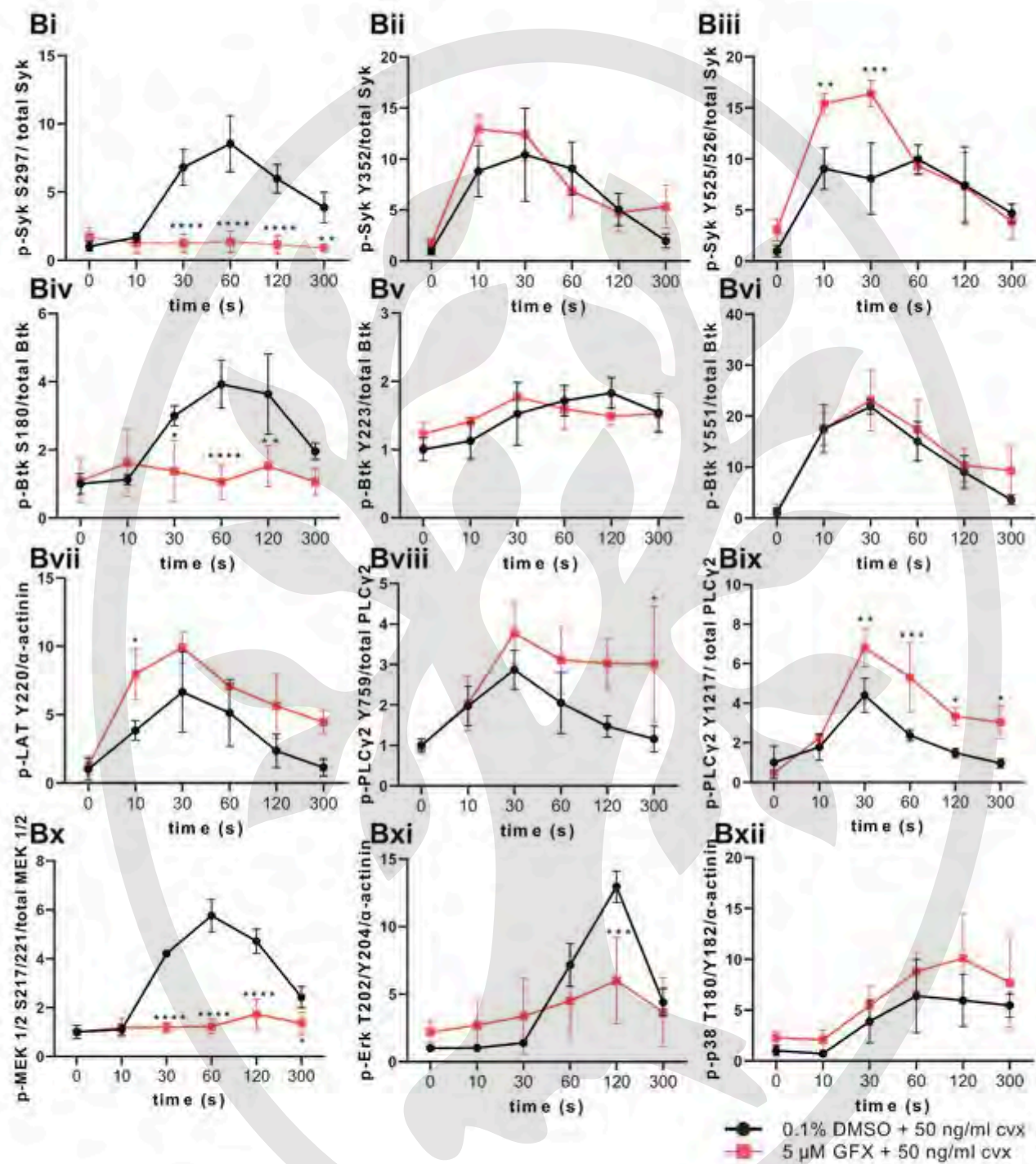


Figure 4



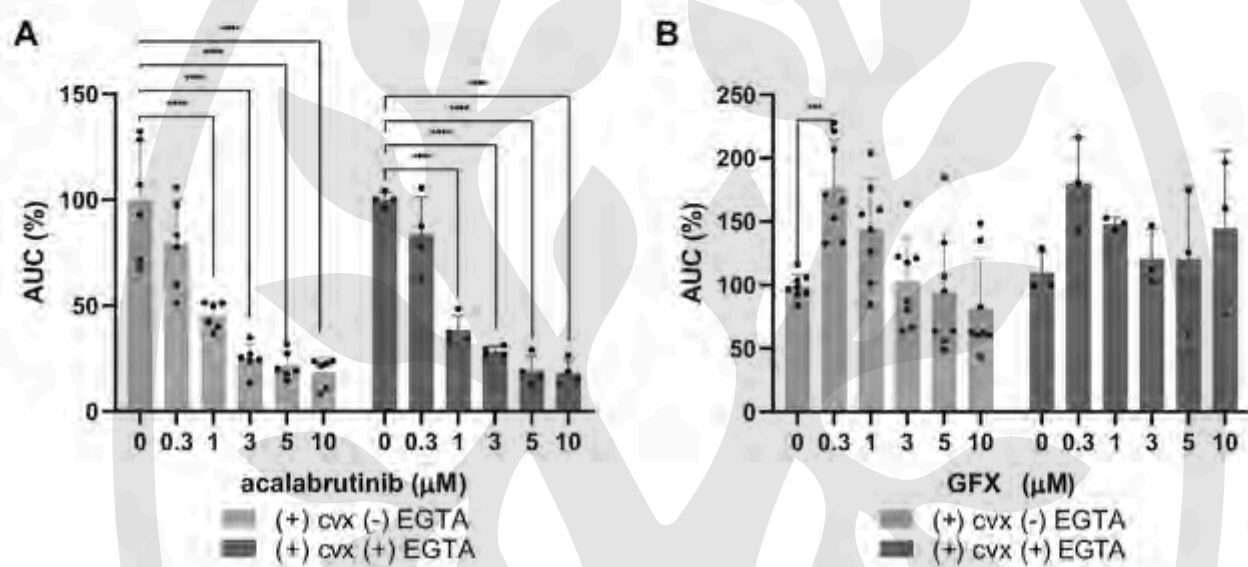


Figure 5



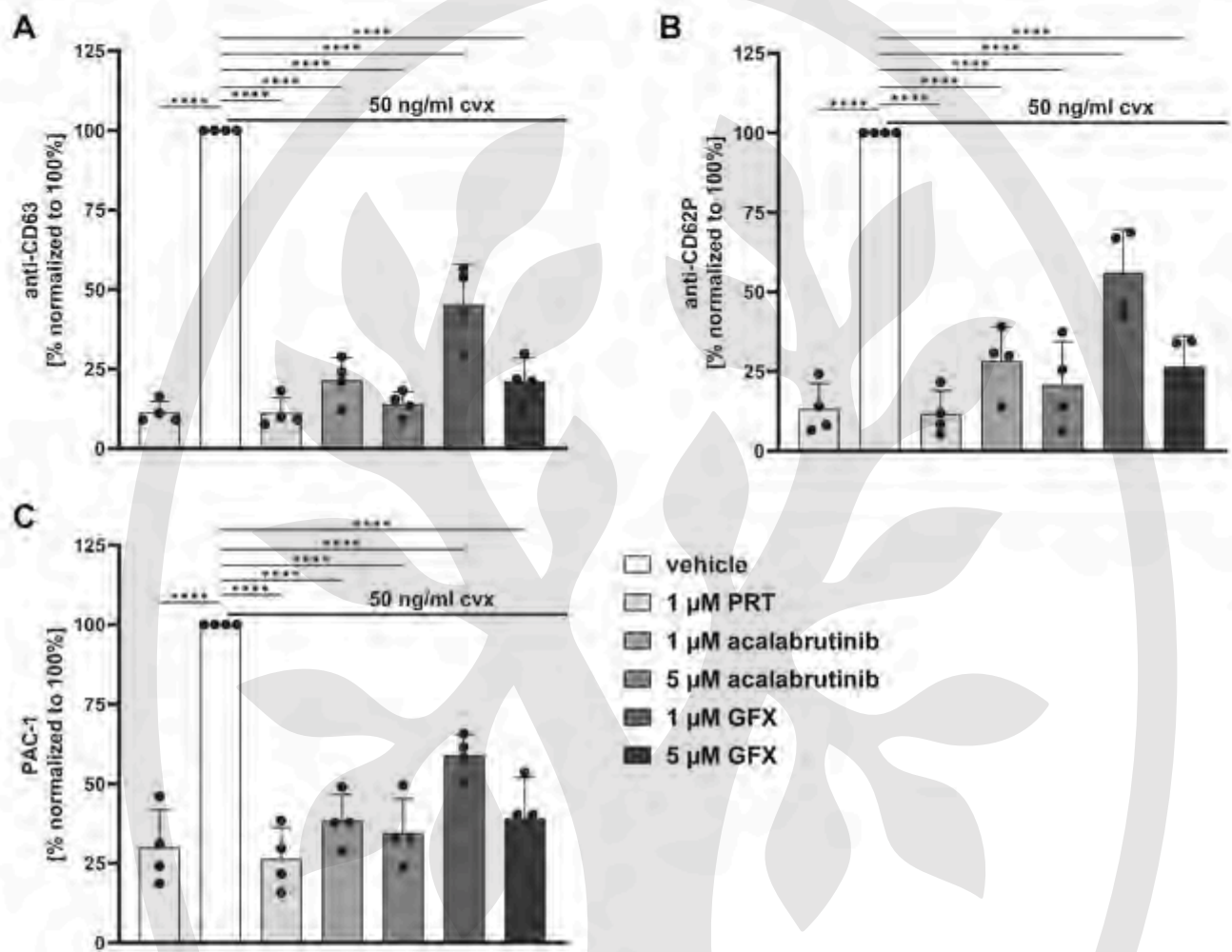


Figure 6





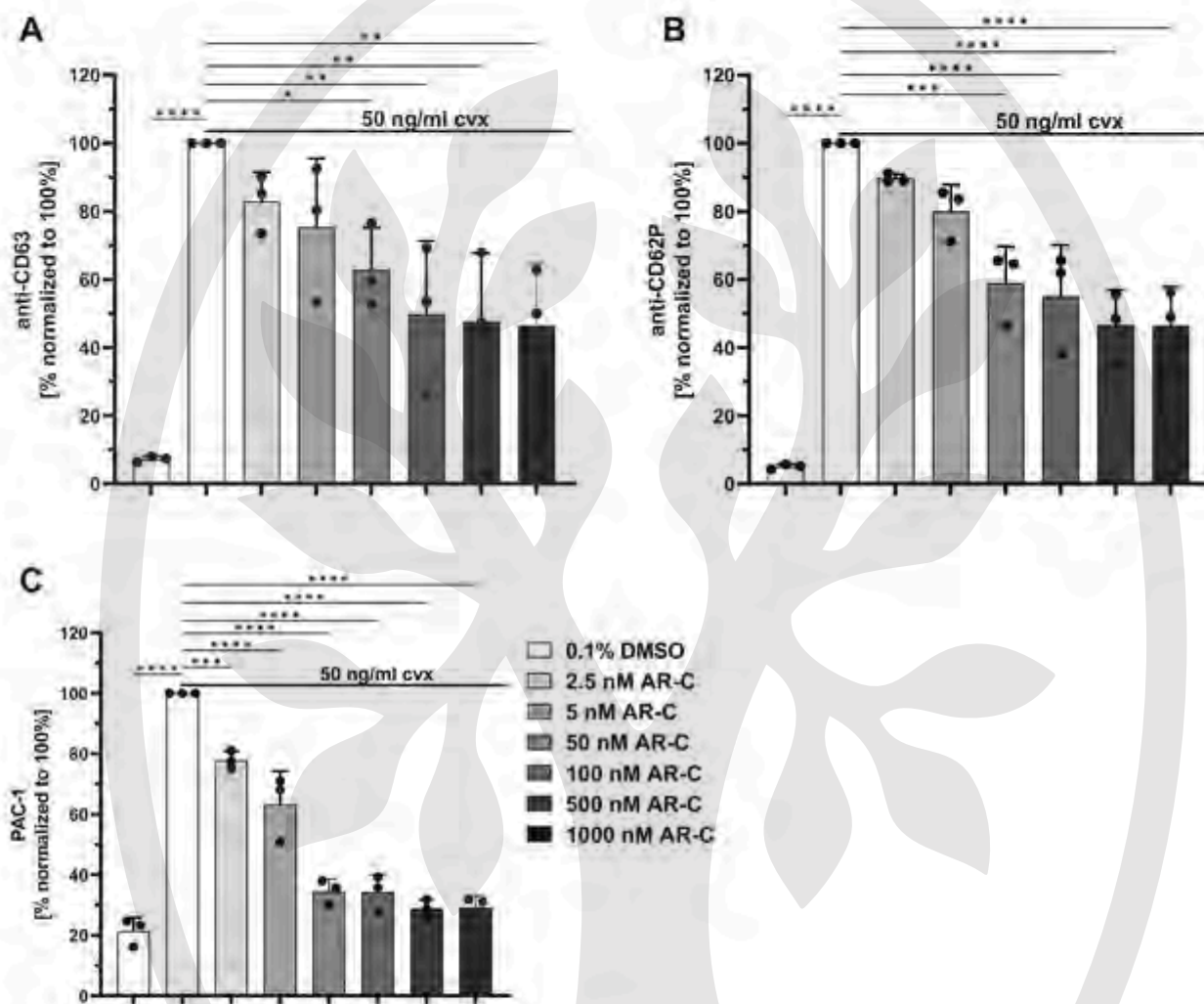


Figure 7



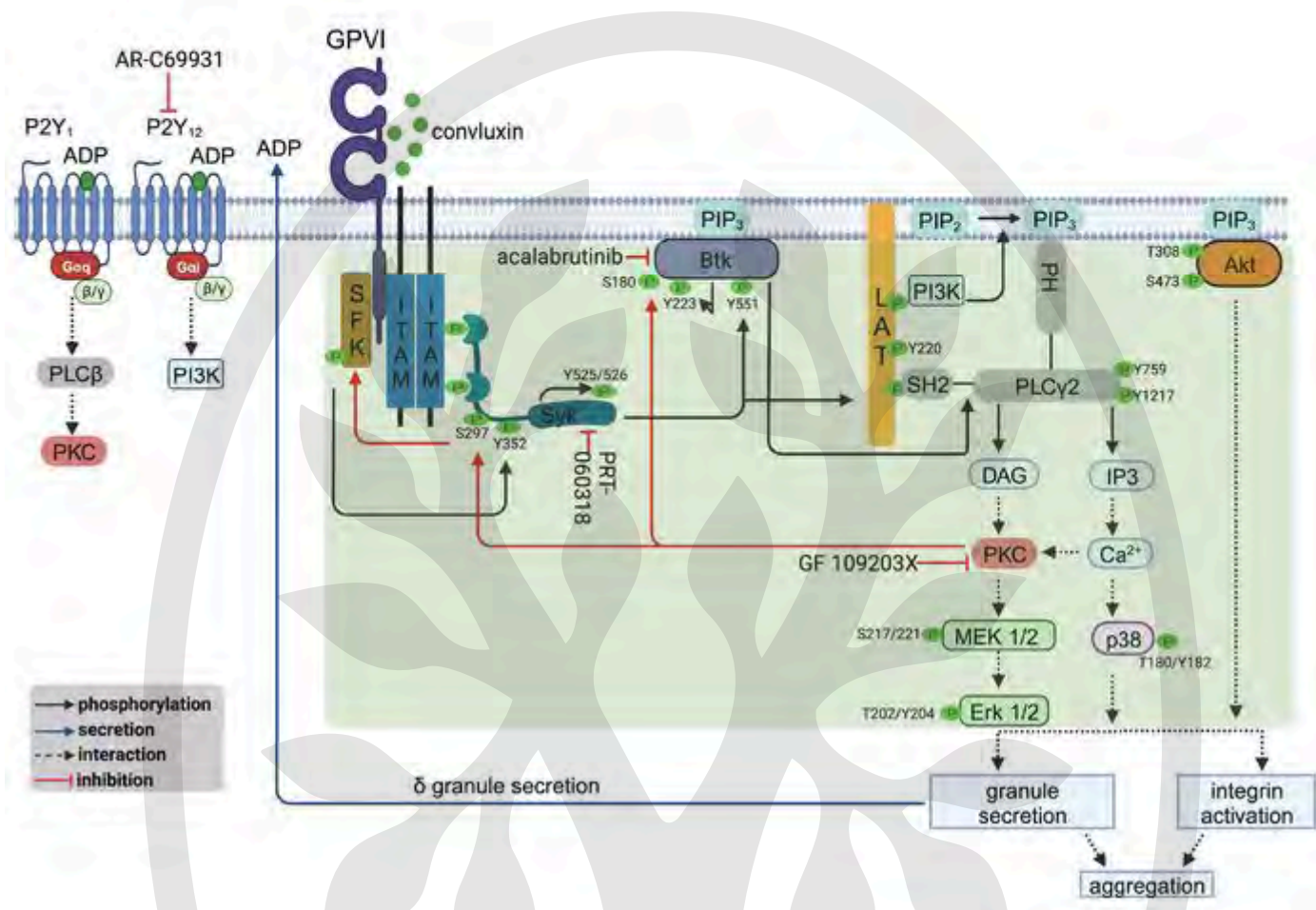


Figure 8

**GPVI-induced sequential activation and interactions of protein kinases and adapter proteins in human platelets**

